



# Panasonic®

## DVD/CD PLAYER

### Operating Instructions

Model No. **DVD-F85**



### *Dear customer*

Thank you for purchasing this product. For optimum performance and safety, please read these instructions carefully before connecting, operating or adjusting this product. Please keep this manual for future reference.



As an ENERGY STAR® Partner, Panasonic has determined that this product meets the ENERGY STAR® guidelines for energy efficiency.

### Region number

The player plays DVD-Video marked with labels containing the region number "1" or "ALL".

Example



The warranty for the U.S.A. is on page 26.

En la página 27 hay una guía de referencia rápida en español.

## Accessories

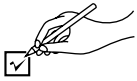

Please check and identify the supplied accessories. Use numbers indicated in parentheses when asking for replacement parts.

*(Only for U.S.A.) To order accessories contact 1-800-332-5368 or web site (<http://www.panasonic.com>).*  
*(For Canada) To order accessories, call the dealer from whom you have made your purchase.*

1 Remote control  
(N2QAJB000070)



2 Remote control batteries

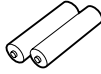

1 AC power supply cord  
(RJA0065-A)

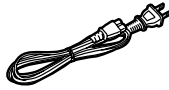

1 Audio/video cable  
(K2KA6CA00001)



[Note]

The included AC power supply cord is for use with this unit only. Do not use it with other equipment.

### User memo:

DATE OF PURCHASE \_\_\_\_\_  
 DEALER NAME \_\_\_\_\_  
 DEALER ADDRESS \_\_\_\_\_  
 \_\_\_\_\_  
 TELEPHONE NUMBER \_\_\_\_\_

The model number and serial number of this product can be found on either the back or the bottom of the unit. Please note them in the space provided below and keep for future reference.

MODEL NUMBER \_\_\_\_\_ DVD-F85 \_\_\_\_\_  
 SERIAL NUMBER \_\_\_\_\_

## Table of contents

### Getting started

Accessories	2
IMPORTANT SAFETY INSTRUCTIONS	4
Maintenance	4
Control reference guide	5
Connection	6
Connection to a television	6
Home Theater – Enjoying more powerful sound	7
Disc information	8
The remote control	9
Quick setup	9

### Basic operations

Basic play	10
Disc type screen	11
Changing the main unit display	11
Sequential play	11
Changing the disc in the play position	11
Changing other discs during play	11
Starting play from a selected item	11
Selecting groups to play	11
Position Memory function	11
Replaying a scene—QUICK REPLAY	11
Navigation menus	12
Playing WMA/MP3/JPEG and CD text	12
Playing HighMAT discs	13
Playing the programs on DVD-RAM	13

### Advanced operations

Convenient features	14
Changing soundtracks, subtitles and angles	14
Selecting still pictures—Page Skip	15
Variable Zoom function	15
To enjoy even higher quality sound—AUDIO ONLY	15
Double re-master—Enjoying more natural sound	15
Setting the unit to turn off—SLEEP timer	15
Changing play sequence	16
Random play	16
Program play	16
Using On-Screen Menu Icons	17
Common procedures	17
Disc information	17
Unit information	18
Progress indicator	19
Changing settings	20
Common procedures	21
Entering a password (Ratings)	21
Digital output	21
Speaker setting	22

### Reference

Glossary	23
Specifications	23
Troubleshooting guide	24
Limited Warranty (ONLY FOR U.S.A.)	26
Product Service	26
Guía de referencia rápida en español	27
(Spanish Quick Reference)	

## CAUTION!

THIS PRODUCT UTILIZES A LASER.  
USE OF CONTROLS OR ADJUSTMENTS OR  
PERFORMANCE OF PROCEDURES OTHER THAN  
THOSE SPECIFIED HEREIN MAY RESULT IN  
HAZARDOUS RADIATION EXPOSURE.  
DO NOT OPEN COVERS AND DO NOT REPAIR  
YOURSELF. REFER SERVICING TO QUALIFIED  
PERSONNEL.

## WARNING:

TO REDUCE THE RISK OF FIRE, ELECTRIC  
SHOCK OR PRODUCT DAMAGE, DO NOT  
EXPOSE THIS APPARATUS TO RAIN,  
MOISTURE, DRIPPING OR SPLASHING AND  
THAT NO OBJECTS FILLED WITH LIQUIDS,  
SUCH AS VASES, SHALL BE PLACED ON  
THE APPARATUS.



## CAUTION

RISK OF ELECTRIC SHOCK  
DO NOT OPEN



CAUTION: TO REDUCE THE RISK OF ELECTRIC  
SHOCK, DO NOT REMOVE SCREWS.  
NO USER-SERVICEABLE PARTS  
INSIDE.  
REFER SERVICING TO QUALIFIED  
SERVICE PERSONNEL.



The lightning flash with arrowhead  
symbol, within an equilateral triangle, is  
intended to alert the user to the presence  
of uninsulated "dangerous voltage" within  
the product's enclosure that may be of  
sufficient magnitude to constitute a risk of  
electric shock to persons.



The exclamation point within an  
equilateral triangle is intended to alert the  
user to the presence of important  
operating and maintenance (servicing)  
instructions in the literature accompanying  
the appliance.

CAUTION	- LASER RADIATION WHEN OPEN. DO NOT STARE INTO BEAM. FDA 21 CFR / Class II
CAUTION	- VISIBLE AND INVISIBLE LASER RADIATION WHEN OPEN. AVOID EXPOSURE TO BEAM. IEC60825-1 / Class 3b
VARNING	- SYNLIIG OCH OSYNLIIG LASERSTRÅLNING NÄR DENNA DEL ÄR ÖPPNAD. BETRÄKTA EJ STRÅLEN.
ADVARSEL	- SYNLIIG OG OSYNLIIG LASERSTRÅLING VED ÅBNING. UNDGÅ UDSETTELSE FOR STRÅLING.
ADVARSEL	- SYNLIIG OG USYNLIIG LASERSTRÅLING NÄR DEKSEL ÄPNES. UNNGÅ EKSPONERING FÖR STRÅLEN.
VARO!	- AVAITAESSA OLET ALTTIINA NÄKYVÄÄ JA NÄKYMATON LASERSÄTEILYLLÄ. ÄLÄ KATSO SÄTEESEEN.
VORSICHT	- SICHTBARE UND UNSICHTBARE LASERSTRÄHLUNG, WENN ABDECKUNG GEÖFFNET. NICHT DEM STRAHL AUSSETZEN.
ATTENTION	- RAYONNEMENT LASER VISIBLE ET INVISIBLE EN CAS D'OUVERTURE. EXPOSITION DANGEREUSE AU FAISCEAU.
注意	- 打开时有可见及不可见激光辐射。避免激光束照射。
注意	- ここを開くと可視及び不可視レーザー光が出ます。 ビームを見たり、触れたりしないで下さい。 RQLXS0054

(Inside of product)

## CAUTION:

TO PREVENT ELECTRIC SHOCK MATCH  
WIDE BLADE OF PLUG TO WIDE SLOT,  
FULLY INSERT.

Before moving the unit, ensure the disc trays are empty.

Failure to do so will risk severely damaging the discs and the unit.

THE FOLLOWING APPLIES ONLY IN THE U.S.A.

## CAUTION:

This equipment has been tested and found to comply with the limits for a Class B digital device, pursuant to Part 15 of the FCC Rules. These limits are designed to provide reasonable protection against harmful interference in a residential installation. This equipment generates, uses and can radiate radio frequency energy and, if not installed and used in accordance with the instructions, may cause harmful interference to radio communications. However, there is no guarantee that interference will not occur in a particular installation. If this equipment does cause harmful interference to radio or television reception, which can be determined by turning the equipment off and on, the user is encouraged to try to correct the interference by one or more of the following measures:

- Reorient or relocate the receiving antenna.
- Increase the separation between the equipment and receiver.
- Connect the equipment into an outlet on a circuit different from that to which the receiver is connected.
- Consult the dealer or an experienced radio/TV technician for help.

Any unauthorized changes or modifications to this equipment would void the user's authority to operate this device.

This device complies with Part 15 of the FCC Rules. Operation is subject to the following two conditions: (1) This device may not cause harmful interference, and (2) this device must accept any interference received, including interference that may cause undesired operation.

# IMPORTANT SAFETY INSTRUCTIONS

Read these operating instructions carefully before using the unit. Follow the safety instructions on the unit and the applicable safety instructions listed below. Keep these operating instructions handy for future reference.

- 1) Read these instructions.
- 2) Keep these instructions.
- 3) Heed all warnings.
- 4) Follow all instructions.
- 5) Do not use this apparatus near water.
- 6) Clean only with dry cloth.
- 7) Do not block any ventilation openings. Install in accordance with the manufacturer's instructions.
- 8) Do not install near any heat sources such as radiators, heat registers, stoves, or other apparatus (including amplifiers) that produce heat.
- 9) Do not defeat the safety purpose of the polarized or grounding-type plug. A polarized plug has two blades with one wider than the other. A grounding-type plug has two blades and a third grounding prong. The wide blade or the third prong are provided for your safety. If the provided plug does not fit into your outlet, consult an electrician for replacement of the obsolete outlet.
- 10) Protect the power cord from being walked on or pinched particularly at plugs, convenience receptacles, and the point where they exit from the apparatus.
- 11) Only use attachments/accessories specified by the manufacturer.
- 12) Use only with the cart, stand, tripod, bracket, or table specified by the manufacturer, or sold with the apparatus. When a cart is used, use caution when moving the cart/apparatus combination to avoid injury from tip-over.
- 13) Unplug this apparatus during lightning storms or when unused for long periods of time.
- 14) Refer all servicing to qualified service personnel. Servicing is required when the apparatus has been damaged in any way, such as power-supply cord or plug is damaged, liquid has been spilled or objects have fallen into the apparatus, the apparatus has been exposed to rain or moisture, does not operate normally, or has been dropped.



## Maintenance

**Clean this unit with a soft, dry cloth.**

- Never use alcohol, paint thinner or benzine to clean this unit.

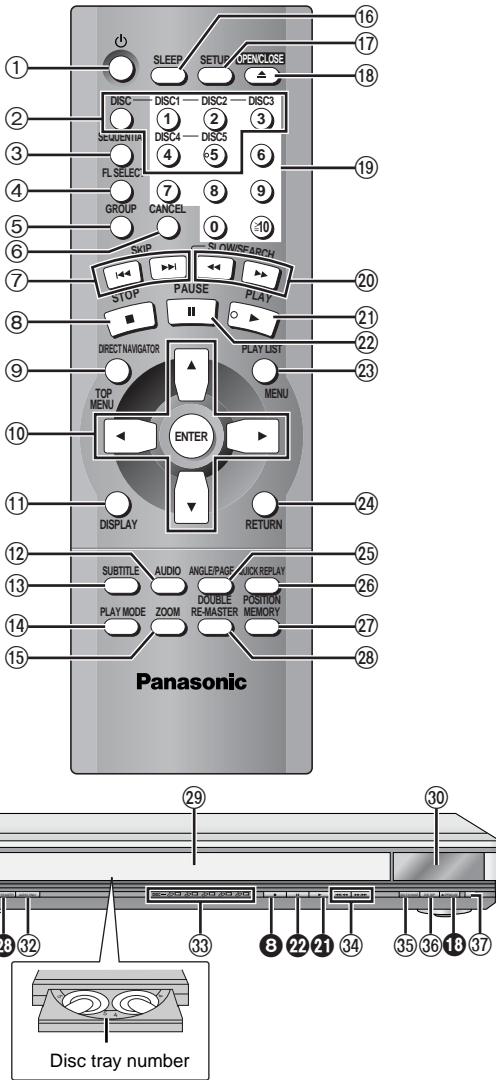

Buttons such as 8 function the same as those on the remote control.

①	Standby/on button (⏻)	9
②	Disc select button (DISC), Disc buttons (DISC 1–DISC 5)	11
③	Sequential button (SEQUENTIAL)	11
④	FL select button (FL SELECT)	11
⑤	Group button (GROUP)	11
⑥	Cancel button (CANCEL)	16
⑦	Skip buttons (⏮, ⏭ SKIP)	10
⑧	Stop button (■ STOP)	10
⑨	Top menu, Direct navigator button (TOP MENU, DIRECT NAVIGATOR)	10, 13
⑩	Cursor buttons (▲, ▼, ◀, ▶), Enter button (ENTER)	9
⑪	Display button (DISPLAY)	17
⑫	Audio button (AUDIO)	14
⑬	Subtitle button (SUBTITLE)	14
⑭	Play mode button (PLAY MODE)	16
⑮	Zoom button (ZOOM)	15
⑯	Sleep button (SLEEP)	15
⑰	Setup button (SETUP)	9, 21
⑱	Drawer open/close button (▲ OPEN/CLOSE)	10
⑲	Numbered buttons (1–9, 0, ≙10)	11
⑳	Slow/Search buttons (◀◀, ▶▶ SLOW/SEARCH)	10
㉑	Play button (▶ PLAY)	10
㉒	Pause button (⏸ PAUSE)	10
㉓	Menu, Play list button (MENU, PLAY LIST)	10, 13
㉔	Return button (RETURN)	9
㉕	Angle/page button (ANGLE/PAGE)	14, 15
㉖	Quick replay button (QUICK REPLAY)	11
㉗	Position memory button (POSITION MEMORY)	11
㉘	Double re-master button (DOUBLE RE-MASTER)	15
㉙	Drawer	10
㉚	FL Display	10
㉛	Standby/on switch (POWER ⏻/⏿)	9
	Press to switch the unit from on to standby mode or vice versa. In standby mode, the unit is still consuming a small amount of power.	
㉜	Audio only button (AUDIO ONLY)	15
㉝	Disc indicators (DISC 1–5)	10
㉞	Skip, Search buttons (⏮/◀◀, ▶▶/⏭)	10
㉟	Disc exchange button (DISC EXCHANGE)	11
㊱	Disc skip button (DISC SKIP)	10
㊲	Remote control signal sensor	

# Connection

## Before connection

- Disconnect the AC power supply cord.
- Turn off all equipment and read the appropriate operating instructions.
- The equipment connections described are examples.
- Peripheral equipment and optional cables sold separately unless otherwise indicated.

## Connection to a television

This page explains how to connect the unit to a television and set it up so you hear the audio through the television's speakers. To get the full benefit from the powerful multi-channel audio found on DVDs, you should connect an amplifier and speakers.

### Do not place the unit on amplifiers or equipment that may become hot.

The heat can damage the unit.

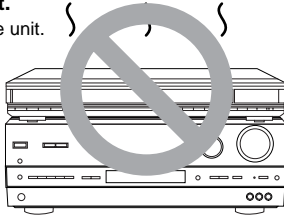

### Connect your unit directly to your television.

Do not connect the unit through your video cassette recorder when setting up your home entertainment system, because the picture may not be played correctly due to the copy guard.

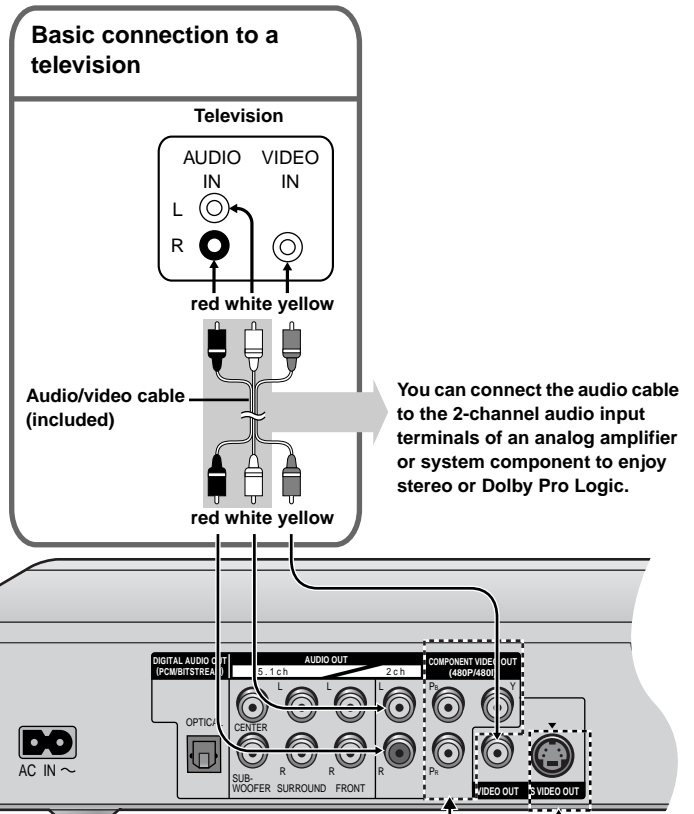

### For better pictures

#### Television's COMPONENT VIDEO IN terminals

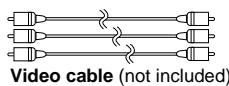

#### COMPONENT VIDEO OUT terminal

These terminals can be used for either interlace or progressive output (→ page 9) and provide a purer picture than the S VIDEO OUT terminal. Connection using these terminals outputs the color difference signals (P<sub>B</sub>/P<sub>R</sub>) and luminance signal (Y) separately in order to achieve high fidelity in reproducing colors. The description of the component video input terminals depends on the television or monitor (e.g. Y/P<sub>B</sub>/P<sub>R</sub>, Y/B-Y/R-Y, Y/C<sub>B</sub>/C<sub>R</sub>). Connect to terminals of the same color.

- After making this connection, change the black level for a better picture. (→ page 20, Video—Black Level Control)

#### Television's S VIDEO IN terminal

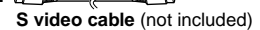

#### S VIDEO OUT terminal

The S video terminal achieves a more vivid picture than the VIDEO OUT terminal by separating the chrominance (C) and luminance (Y) signals. (Actual results depend on the television.)

When making this connection, ensure you connect the audio cables to the corresponding audio input terminals on the television.

## Power connection

### Conserving power

This unit consumes a small amount of power, even when it is turned off (approx. 0.6 W).

To save power when the unit is not to be used for a long time, unplug it from the household AC outlet.

#### Household AC outlet (AC 120 V, 60 Hz)

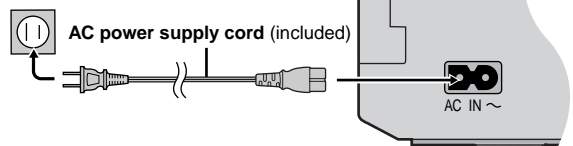

## Home Theater – Enjoying more powerful sound

Enjoy the powerful movie theater and hall-like sound available with multiple channel audio found on DVDs by connecting an amplifier and speakers. There are two types of connection, digital and analog.

### |\ Digital

Connect an amplifier with Dolby Digital and DTS decoders to enjoy surround sound.

You can also enjoy high-quality stereo sound with sampling frequencies such as 96 and 192 kHz if the material isn't copy-protected and the equipment you connect is compatible with these signals.

### [Note]

If you don't connect a subwoofer, it is advisable to connect front speakers (L/R) capable of producing bass of less than 100 Hz.

### |\ Analog

Connect an amplifier with multi-channel audio input terminals to enjoy surround sound.

This unit can decode Dolby Digital and DTS and there are no limitations on sampling frequency with this kind of connection.

To obtain maximum performance of DVD-Audio multi-channel linear PCM sound, the connections |\B| below are recommended.

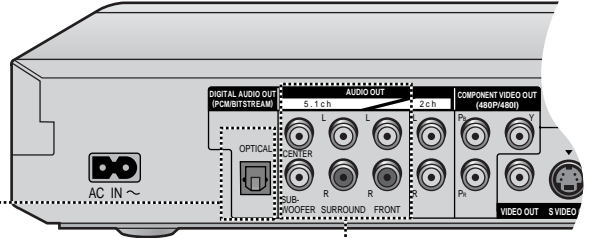

### A Digital connection

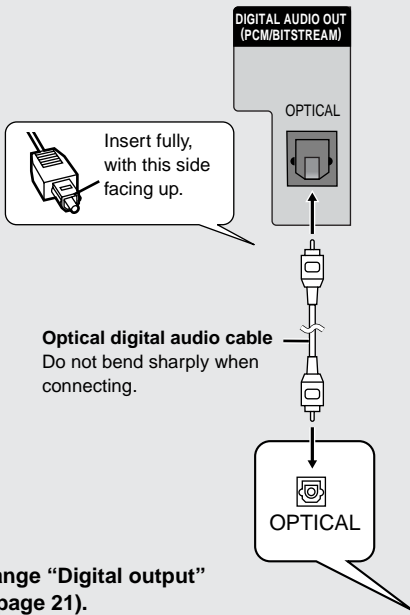

- You can connect to a digital amplifier or system component to enjoy stereo or Dolby Pro Logic.

### B Analog connection

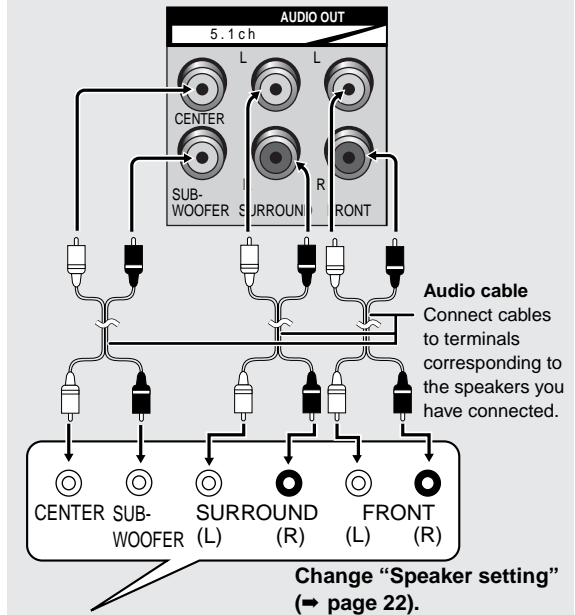

- Switch the attenuator on if sound is distorted with this connection (→ page 19).

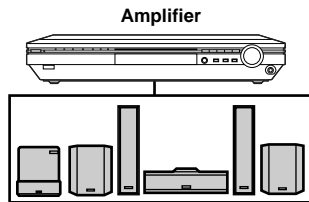

Speakers (example)

Connect three or more speakers for surround sound.

## ■ Recording Output

### Digital recording

Connection [A] to digital recording equipment

- With DVD, the following conditions must be met: ① the disc doesn't have protection preventing digital recording, and ② the recording equipment can handle signals with a sampling frequency of 48 kHz.
- You cannot record WMA/MP3.

When recording, make the following settings.









- Advanced surround: OFF (→ page 19)
- PCM Digital Output: Up to 48 kHz (→ page 21)
- Dolby Digital/DTS Digital Surround: PCM (→ page 21)

### Analog recording

There are no limitations on recording analog signals as there are with digital signals.

- Connect the equipment to the unit's 2-channel AUDIO OUT (L/R) terminals.
- or
- Select "2-channel" in "Speaker Setting" (→ page 20) when connecting the equipment to the unit's FRONT (L/R) 5.1-channel AUDIO OUT terminals.

## Discs that can be played

DVD-RAM	DVD-Audio	DVD-Video	DVD-R	SVCD	Video CD	CD	CD-R/RW
 R A M R A M 4.7  Shown as "DVD-VR" on the display	 A U D I O	 V I D E O   V I D E O	 R R 4.7	 C O M P A C T d i s c S U P E R V I D E O  Conforming to IEC62107	 C O M P A C T d i s c D I G I T A L V I D E O	 C O M P A C T d i s c D I G I T A L A U D I O T E X T   C O M P A C T d i s c D I G I T A L A U D I O	-
[RAM]	[DVD-A]	[DVD-V]		[VCD]		[CD]	[WMA] [MP3] [JPEG]

Use discs with the above logos and that conform to specifications. The unit cannot play other discs correctly. Do not use irregularly shaped discs (e.g. heart-shaped), as these can damage the unit.

It may not be possible to play CD-R, CD-RW, DVD-R and DVD-RAM in all cases due to the type of disc or condition of the recording.

## Discs that cannot be played

DVD-ROM, CD-ROM, CDV, CD-G, +RW, DVD-RW, CVD, SACD, Divx Video Discs, Photo CD, DVD-RAM that cannot be removed from their cartridge, 2.6-GB and 5.2-GB DVD-RAM, and "Chaoji VCD" available on the market including CVD, DVCD and SVCD that do not conform to IEC62107.

## Built-in decoders

You can play discs with these symbols.



## Video systems

NTSC is used. This unit converts still pictures on PAL system DVD-Audio discs for play on NTSC video systems. The picture is compressed to show it in its entirety, but this may cause it to be stretched vertically.

## Playing DVDs and Video CDs

The producer of these discs can control how they are played so you may not always be able to control play as described in these operating instructions (for example if the play time is not displayed or if a Video CD has menus). Read the disc's instructions carefully.

## DVD-RAM discs

The DVD-RAM you can play on this unit are those recorded with DVD video recorders, DVD video cameras, personal computers, etc. using Version 1.1 of the Video Recording Format (a unified video recording standard).

- Remove discs from their cartridges before use and return them when you are finished, making sure that the labels of the disc and cartridge face the same way.
- Some parts of the disc, for example where one program ends and another begins, may not play smoothly.

## DVD-R discs

Panasonic DVD-R recorded and finalized on a Panasonic DVD video recorder or DVD video camera are played as DVD-Video on this unit.

## CD-R and CD-RW discs

This unit can play CD-R/RW (audio recording disc) recorded with CD-DA, video CD, SVCD (conforming to IEC62107), WMA, MP3, or JPEG. Close the session or finalize after recording.

See page 13 for more information about WMA, MP3, and JPEG.

## HighMAT discs

This unit is compatible with HighMAT discs containing WMA, MP3, and/or JPEG files.

## Disc structure

Disc structure and the labels given to the items on discs depend on the disc type.

**Track:** the smallest division on DVD-Audio, CDs, and Video CDs, or a single WMA/MP3 file.

**Chapter:** the smallest division on DVD-Video.

**Group:** collections of tracks on DVD-Audio and equivalent to folders or albums on data discs.

**Title:** the largest division on DVD-Video, usually an entire movie.

**Program:** the division on DVD-RAM equivalent to a single recording.

**Picture:** a single JPEG file.

**Play list:** the largest grouping on a HighMAT disc, or a group of scenes on DVD-RAM.

**Scene:** DVD-RAM program sections specified and grouped into play lists on a DVD video recorder.

**Content:** covers tracks and pictures on HighMAT discs.

## To clean discs

### DVD-Audio, DVD-Video, Video CD, CD

Wipe with a damp cloth and then wipe dry.

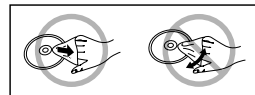

### DVD-RAM, DVD-R

- Clean only with an optional DVD-RAM/PD disc cleaner (LF-K200DCA1, where available).
- Never use cloths or cleaners for CDs etc.

## Handling precautions

- Do not write on the label side with a ball-point pen or other writing instrument.
- Do not use record cleaning sprays, benzene, thinner, static electricity prevention liquids or any other solvent.
- Do not attach labels or stickers to discs. (Do not use discs with exposed adhesive from tape or left over peeled-off stickers.)
- Do not use scratch-proof protectors or covers.
- Do not use discs printed with label printers available on the market.



# The remote control

## Batteries

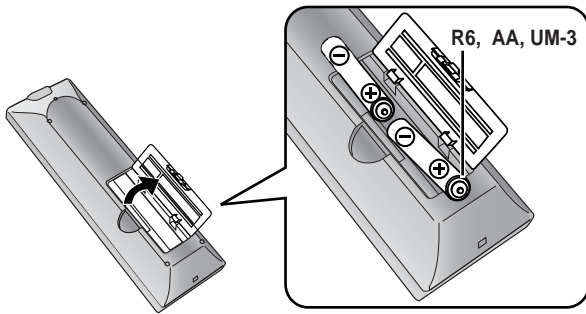

- Insert so the poles (+ and -) match those in the remote control.
- Do not use rechargeable type batteries.

## Do not:

- mix old and new batteries.
  - use different types at the same time.
  - heat or expose to flame.
  - take apart or short circuit.
  - attempt to recharge alkaline or manganese batteries.
  - use batteries if the covering has been peeled off.
- Mishandling of batteries can cause electrolyte leakage which can damage items the fluid contacts and may cause a fire.

Remove if the remote control is not going to be used for a long period of time. Store in a cool, dark place.

## Use

Aim at the sensor (→ page 5, Control reference guide), avoiding obstacles, at a maximum range of 7 m (23 feet) directly in front of the unit.

## Quick setup

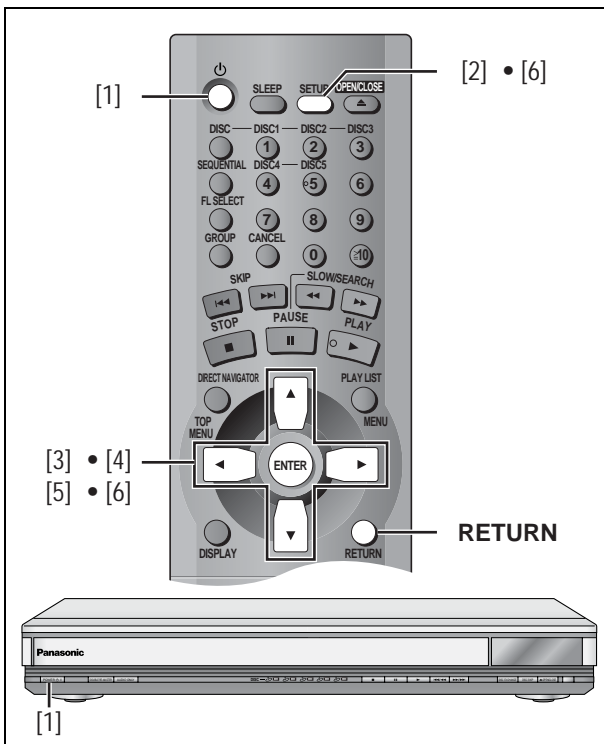

The **QUICK SETUP** screen appears when you press [SETUP] the first time after purchase and assists you to make necessary settings.

### Preparation

Turn on the television and select the appropriate video input on the television to suit the connections for the player.

## TV Aspect

Select **"4:3"** (regular) or **"16:9"** (widescreen) to suit your television. If you have a regular 4:3 television, you can also select how video on some discs is shown (→ page 20, Video—TV Aspect).

### •4:3 Pan&Scan (Factory preset)

Widescreen software is expanded to fill the screen of a 4:3 aspect television (unless prohibited by the producer of the disc).

### •4:3 Letterbox

Widescreen software is shown in the letterbox style on a 4:3 aspect television.



[1] Press [⏻] to turn on the unit.

[2] Press [SETUP] to show the **QUICK SETUP** screen.

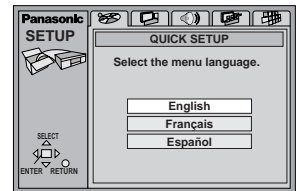

[3] Press [▲, ▼] to select the menu language and press [ENTER].

[4] Press [▲, ▼] to select **"Yes"** to continue and press [ENTER].

[5] Press [▲, ▼] to select the item and press [ENTER].

- Audio Language (→ page 20)
- Subtitle Language (→ page 20)
- TV Type (→ page 20)
- TV Aspect (→ below)
- Progressive Out (→ page 20)
- Speaker Setting (→ page 20)
- PCM Digital Output (→ page 21)

[6] Press [ENTER] and then [SETUP] to end the settings.

### To return to the previous screen

Press [RETURN].

### To access this screen again later

→ page 20, Others—QUICK SETUP

## To enjoy progressive video

1. Connect to the component video input terminals on a 480P compatible television. (Video will not be displayed correctly if connected to an incompatible television.)

2. In QUICK SETUP, set "Progressive Out" to "Enable".

3. Change Video output mode to "480P" (→ page 18).

• All televisions manufactured by Panasonic and that have 480P input connectors are compatible. Consult the manufacturer if you have another brand of television.

• If the unit is connected to the television through VIDEO OUT or S VIDEO OUT, output will be interlace, irrespective of the settings.

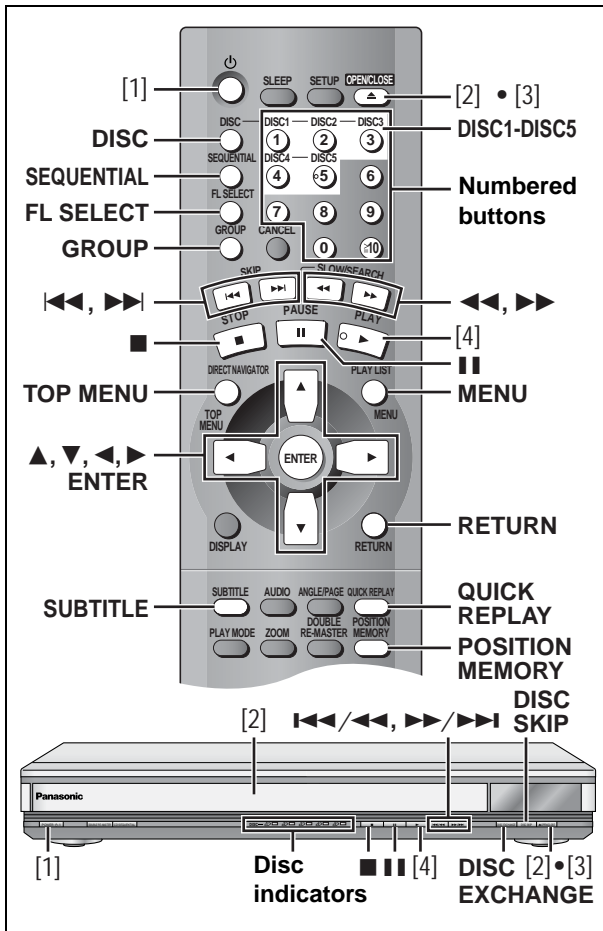

### Preparation

Turn on the television and select the appropriate video input on the television to suit the connections for the player.

- [1] Press [POWER] to turn on the unit.
- [2] Press [▲] to open the drawer and place the disc(s) label-up on the disc tray(s).

To load discs on the other trays, press [DISC SKIP] on the main unit.

- If the disc contains both audio data (WMA and MP3) and JPEG, check the "Mixed Disc—Audio & Stills" setting in the SETUP menu (→ page 20). Select "Stills (JPEG)" or "Audio (MP3/WMA)".
- Load double-sided discs so the label for the side you want to play is facing up.

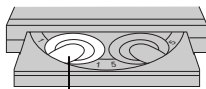

Play starts from the disc in the front-left position.

- [3] Press [▲] to close the drawer.  
A disc indicator lights to show a disc is on the tray.
- [4] Press [▶] (PLAY).

Play begins. It is normal for sound and pictures to take time to start.

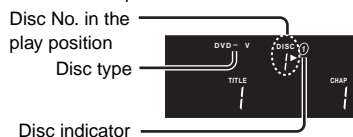

[CD] (CD text only) [WMA] [MP3]

Track information appears on the television. Press [SUBTITLE] to turn the display on or off.

### When the disc finishes playing

If the next disc doesn't start playing, select the disc using the disc type screen (→ page 11).

<b>Stop</b>	Press [■]. "▷" flashes on the display. Press [▶] (PLAY) to restart from this position or [■] to clear it. DVD-Video: Press [▶] (PLAY) again to review chapters (→ page 11).
<b>Pause</b>	Press [⏸]. Press [▶] (PLAY) to restart.
<b>Skip</b>	Press [◀◀] (backward) or [▶▶] (forward). <b>Group skip [JPEG]</b> Press [▼] (backward) or [▲] (forward). <b>Disc skip</b> Press [DISC SKIP] on the main unit.
<b>Search</b>	Press [◀◀] (backward) or [▶▶] (forward). Press [▶] (PLAY) to restart.
<b>Slow-motion</b>	While paused, press [◀◀] (backward) or [▶▶] (forward). Press [▶] (PLAY) to restart.
<b>Frame-by-frame</b>	While paused, press [◀] (backward) or [▶] (forward). Press and hold to change in succession. Or, press [⏸] repeatedly for forward frame-by-frame.
<b>Menus</b>	Press [▲, ▼, ◀, ▶] to select an item and [ENTER] to confirm. Or, press the numbered buttons. Press [TOP MENU] to show the top menu. Press [MENU] to show a menu. Press [RETURN] to show a menu. [VCD]

### Notes

- On the main unit, press [◀◀/◀] or [▶/▶▶] to perform skip, and press and hold to perform search and slow-motion.
- The speed of search and slow-motion increases up to 5 steps.
- Slow-motion and frame-by-frame only work on moving pictures.
- You can turn off the sound during search (→ page 20, Audio—Audio during Search).

### When playing Video CDs

- You cannot move backwards during slow-motion and frame-by-frame.
- Pressing buttons to perform skip, search or slow-motion may take you to a menu screen.

### ● If "⊗" appears on the television

The operation is prohibited by the unit or disc.

- Discs continue to rotate while menus are displayed even after playing an item. Press [■] when you finish to preserve the unit's motor and your television screen.

### ● To prevent damage

Do not;

- load more than one disc per tray.
- touch the drawer or the carousel while they are in motion
- rotate the carousel by hand.
- close the drawer by hand.

## Disc type screen

Check the discs loaded and select a disc to play.

### 1 Press [DISC].

Disc type screen

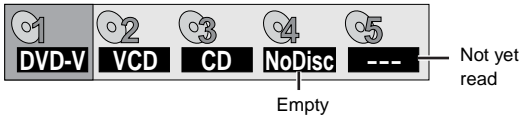

### 2 Press the disc button ([DISC 1] – [DISC 5]).

To clear the screen

Press [DISC].

## Changing the main unit display

### Press [FL SELECT].

Each time you press the button:

Program/Play list/Group/Title/  
Chapter/Track/Picture/Content  
number display

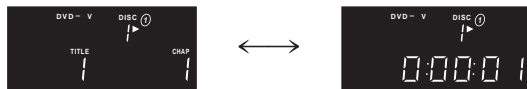

## Sequential play

[VCD] [CD] [WMA] [MP3]

The unit usually plays the disc in the play position and then stops. Turn sequential play on to play all loaded discs, except for DVDs and JPEG discs.

### Press [SEQUENTIAL].

Each time you press the button:

SEQ on ↔ SEQ off

- On the main unit, press [CD SEQUENTIAL].
- HighMAT menus and Video CD playback control are disabled.
- You cannot change the mode during program or random play.
- Sequential Mode turns off when you switch the unit to standby.

## Changing the disc in the play position

Main unit only

### 1 Press [DISC EXCHANGE].

The drawer opens and the disc in the play position comes to the front-left position.

### 2 Change the disc in the front-left position.

### 3 Press [DISC EXCHANGE].

## Changing other discs during play

You can change the other discs without interrupting play.

Main unit only

### 1 Press [▲] to open the drawer.

### 2 Press [DISC SKIP] to rotate the carousel.

The carousel moves one tray clockwise and each subsequent press moves it two trays in alternate directions.

### 3 Change the disc and press [▲].

## Starting play from a selected item

[RAM] [DVD-A] [DVD-V] [VCD] [CD]

Press the numbered buttons.

To select a 2-digit number

e.g. 23: [≧10] → [2] → [3]

[WMA] [MP3] [JPEG]

Press the numbered buttons then press [ENTER].

e.g. 123: [1] → [2] → [3] → [ENTER]

- This works only when stopped with some discs.
- When playing DVD-Audio and you want to start play from a track in a different group, select the group first (→ right).

## Selecting groups to play

[DVD-A] [WMA] [MP3] [JPEG]

### 1 Press [GROUP].

### 2 Press [▲, ▼] to select the group number and press [ENTER].

### 3 Press [▲, ▼] to select the track/picture number and press [ENTER].

- You can also select the group and track/picture number with the numbered buttons.

### •Playing bonus groups

Some discs contain bonus groups. If a password screen appears after selecting a group, enter the password with the numbered buttons. Refer also to the disc's jacket.

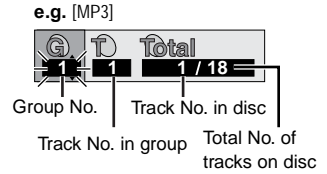

## Position Memory function

[RAM] [DVD-A] [DVD-V] [VCD] [CD] [WMA] [MP3]

(When the elapsed play time is displayed)

[JPEG]

Memorize positions on up to five discs to restart play after switching the unit to standby or changing discs.

During play

### 1 Press [POSITION MEMORY].

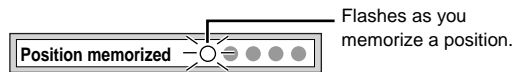

### 2 Press [⏻] to switch the unit to standby, or change the disc.

### 3 When you are ready to play the disc again Press [▶] (PLAY) to restart from the position.

- When you memorize the sixth position, the earliest position is replaced.
- This function does not work while playing some DVDs or play lists on DVD-RAM.
- You cannot recall the position in Sequential Mode.

## Chapter Review [DVD-V]

This message appears.

Press PLAY to Preview Chapters

Press [▶] (PLAY) again to review the first few seconds of the chapters up to the one where you memorized the position. Play then resumes from the memorized position.

Do not press [▶] (PLAY) if you do not want to review chapters.

## Replaying a scene—QUICK REPLAY

[RAM] [DVD-A] [DVD-V] [VCD] [CD] [WMA] [MP3]

Skip back a few seconds within the current item (program, track or title).

[JPEG]

Skip back a few pictures.

During play

### Press [QUICK REPLAY].

- This feature may not work while playing some parts of a disc or at all with some discs.

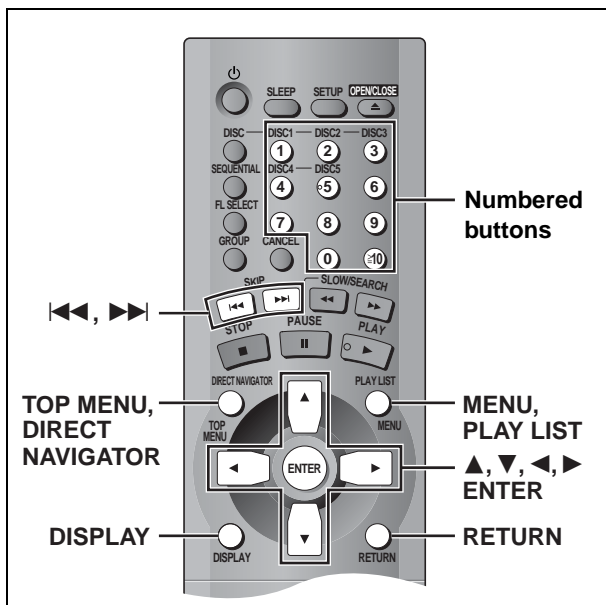

## Track title search [CD] (CD text only) [WMA] [MP3]

Example: finding a track including the word "LOVE".

While the menu is displayed

- Press [▲, ▼] to select "Find" and press [ENTER].
- Press [▲, ▼] to select "L" and press [ENTER].  
Only uppercase appear but the search also includes lower case. Characters change in alphanumeric order each time you press [▲].  
  - Press [◀▶] to skip between A, E, I, O and U.
  - Press [←] to erase a character.
  - You can erase the asterisk (\*) to search for the first word in a title.
  - You can enter numbers with the numbered buttons. Repeat this step to enter "O", "V", and "E".
- Press [▶] to select "Find" and press [ENTER].  
The search results screen appears.
- Press [▲, ▼] to select the track and press [ENTER].

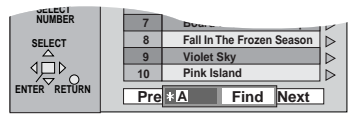

## Playing WMA/MP3/JPEG and CD text

If the disc contains both audio data (WMA and MP3) and JPEG, check the "Mixed Disc—Audio & Stills" setting in the SETUP menu (→ page 20). Select "Stills (JPEG)" or "Audio (MP3/WMA)".

These menus help you find items to play.  
[CD] (CD text only) [WMA] [MP3] [JPEG]

- Press [TOP MENU].

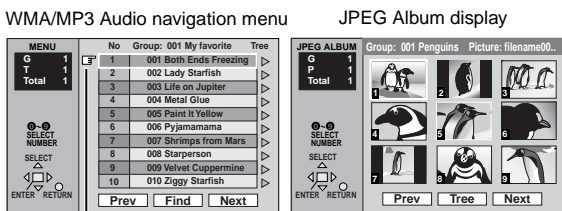

"▶" indicates the track currently playing.

- Press [▲, ▼] to select the track or [▲, ▼, ◀, ▶] to select the picture, and press [ENTER].

To show other pages, press [▲, ▼, ◀, ▶] to select "Prev" or "Next" and press [ENTER].

- After listing all the tracks or pictures in one group, the list for the next group appears.

To exit the menu  
Press [TOP MENU].

## To use the contents screen to find a track [CD] (CD text only)

You can use the text information recorded on these discs to find a track to play.  
While the menu is displayed

- Press [▶] while a track is highlighted to display the contents screen.
- Press [◀, ▶] to move through the tracks and press [ENTER].

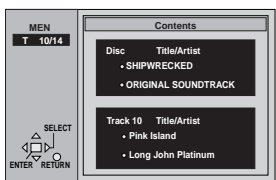

To return to the menu  
Press [RETURN].

To return to the menu  
Press [RETURN].

## To use the tree screen to find a group [WMA] [MP3] [JPEG]

While the menu is displayed

- [WMA] [MP3]  
Press [▶] while a track is highlighted to display a tree screen.  
[JPEG]  
Press [▲, ▼, ◀, ▶] to select "Tree" and press [ENTER].

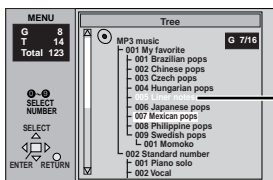

You cannot select groups that contain no compatible files.

- Press [▲, ▼, ◀, ▶] to select a group and press [ENTER].

The audio navigation menu/album display for the group appears.

To return to the menu  
Press [RETURN].

MPEG Layer-3 audio decoding technology licensed from Fraunhofer IIS and Thomson multimedia.

Windows Media, and the Windows logo are trademarks, or registered trademarks of Microsoft Corporation in the United States and/or other countries.

WMA is a compression format developed by Microsoft Corporation. It achieves the same sound quality as MP3 with a file size that is smaller than that of MP3.



[Note]  
[WMA]

- You cannot play WMA files that are copy protected.
  - WMA files must have the extension ".WMA" or ".wma".
- [MP3]
- This unit is not compatible with ID3 tags.
  - If you play an MP3 track that includes still picture data, it will take some time before the music itself starts playing and the elapsed time will not be displayed during this time. Even after the track starts, the correct play time will not be displayed.
  - MP3 files must have the extension ".MP3" or ".mp3".

[JPEG]

- To view JPEG files on this unit:
- Take them on a digital camera that meets the DCF (Design rule for Camera File system) standard.
- Do not alter the files in any way or save them under a different name.
- Ensure they have the extension ".JPG", ".jpg", ".JPEG", or ".jpeg".
- This unit cannot display moving pictures, MOTION JPEG and other such formats, still pictures other than JPEG (i.e. TIFF) or play associated sound.

[WMA] [MP3] [JPEG]

- Discs must conform to ISO9660 level 1 or 2 (except for extended formats).
- This unit is compatible with multi-session but if there are a lot of sessions it takes more time for play to start. Keep the number of sessions to a minimum to avoid this.

### Naming folders and files

At the time of recording, prefix folder and file names with 3-digit numbers in the order you want to play them (this may not work at times).

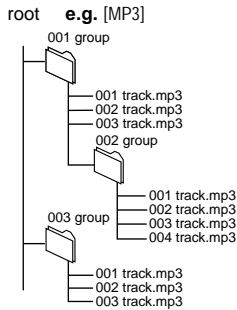

## Playing the programs on DVD-RAM

[RAM]

Use the program list to find programs to play.

### 1 Press [DIRECT NAVIGATOR].

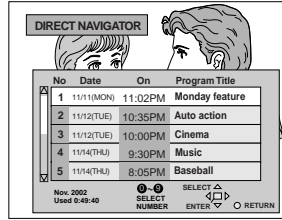

- Titles appear only if you have entered them.
- You cannot change program and disc titles.

### 2 Press [▲, ▼] to select the program.

The selected program plays in the background.

- You can select programs with the numbered buttons.

To select a 2-digit number  
e.g. 23: [≧10] → [2] → [3]

### 3 Press [ENTER].

The program being played in the background continues.

#### To clear the program list

Press [DIRECT NAVIGATOR].

#### To play a play list

You can play a play list created on other equipment such as a DVD video recorder.

### 1 Press [PLAY LIST].

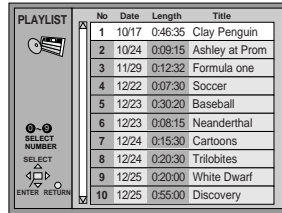

### 2 Press [▲, ▼] to select the play list.

- You can select play lists with the numbered buttons.

To select a 2-digit number  
e.g. 23: [≧10] → [2] → [3]

### 3 Press [ENTER] to start play.

- To skip scenes, press [◀◀] or [▶▶].

#### To clear the play list screen

Press [PLAY LIST].

## Playing HighMAT discs

A menu appears when you select the disc.

Press [▲, ▼, ◀, ▶] to select then press [ENTER].

When you press [ENTER]:



Menu: Takes you to the next menu which shows play lists or another menu



Play list: play starts

- To return to the menu screen  
Press [TOP MENU].
- To return to the menu above the current one  
Press [RETURN].
- To change the menu background  
Press [DISPLAY].  
The background changes to the one recorded on the disc.

### Selecting from the lists

While playing

#### 1 Press [MENU].

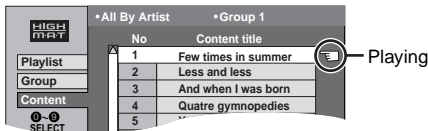

#### 2 Press [◀] then [▲, ▼] to switch between the play list, group and content lists.

#### 3 Press [▶] then [▲, ▼] to select an item and press [ENTER].

- To exit the list screen

Press [MENU].



HighMAT and the HighMAT logo are either trademarks or registered trademarks of Microsoft Corporation in the United States and/or other countries.

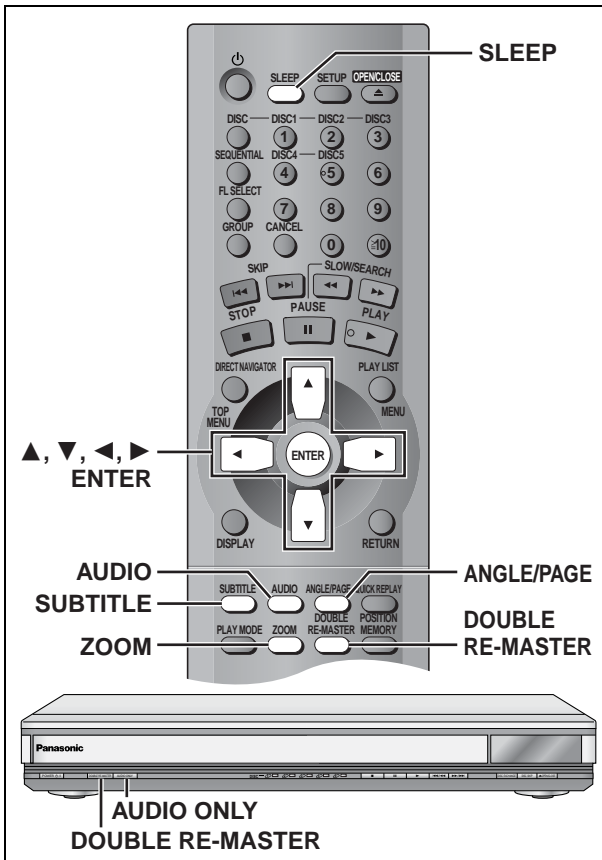

## Changing soundtracks, subtitles and angles

Some discs have multiple soundtracks, subtitle languages and camera angles, and you can change them during play.

- “-” or “- -” is displayed instead of the language number in circumstances such as when no language is recorded on the disc. [VCD] (SVCD only)

Soundtrack and subtitle numbers may change even if corresponding soundtracks are not recorded.

### Soundtracks

[RAM] [DVD-A] [DVD-V] [VCD]

During play  
Press [AUDIO].

[RAM] [VCD]  
Each time you press the button:  
LR → L → R e.g. [RAM]



[DVD-A]  
Soundtrack playing

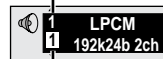

Soundtrack selected

[DVD-V]

The number changes each time you press the button.



- “D.MIX” indicates that a multi-channel soundtrack can be down-mixed to two channels.



- Play restarts from the beginning of the soundtrack when playing DVD-Audio and DVD-RAM soundtracks that are accompanied by still pictures.

- Even if a second soundtrack isn't recorded on a DVD-Audio, two soundtrack numbers will normally be shown when you press [AUDIO]. The soundtrack currently playing is number 1.

- You can also use this button to turn the vocals on and off on karaoke discs. Read the disc's instructions for details.

- Refer to [B] (→ page 17) for audio signal type details.

### Subtitles

[DVD-A] (Moving picture part) [DVD-V] [VCD] (SVCD only)

You can change the subtitle language and turn the subtitles on and off. [RAM]

You can turn the subtitles on and off.

During play

Press [SUBTITLE].

The number changes each time you press the button.

e.g. [DVD-V]

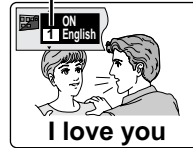

- In some cases, the subtitle language is not changed to the selected one immediately.
- If the subtitles overlap closed captions recorded on discs, turn the subtitles off.

To clear/display the subtitles

1. Press [SUBTITLE].
2. Press [▶]. ([DVD-A] [DVD-V] [VCD])
3. Press [▲, ▼] to select “OFF” or “ON”.

### Changing the position and brightness of the subtitles

1. While the subtitle icon is on the screen, press [◀, ▶] to highlight “Subtitle Position” or “Subtitle Brightness”.



Subtitle Position      Subtitle Brightness

2. Press [▲, ▼] to adjust.
- Adjust position between 0 and -60 in 2 unit steps.
  - For brightness, select “Auto” so the brightness adjusts automatically against the background, or a level between 0 and -9.

### Angles

[DVD-A] [DVD-V]

During play

Press [ANGLE/PAGE].

The angle changes each time you press the button.

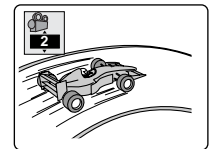
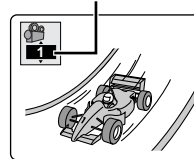

[JPEG]

You can rotate pictures ninety degrees.

While a picture is displayed

- 1 Press [ANGLE/PAGE].
- 2 Press [▲, ▼] to select “Rotate right” or “Rotate left” and press [ENTER].

- To clear the popup screen Press [ANGLE/PAGE].

## Selecting still pictures—Page Skip

[DVD-A]

During play

Press **[ANGLE/PAGE]**.

The page changes each time you press the button.

PAGE 1

## Variable Zoom function

[RAM] [DVD-A] (Moving picture part) [DVD-V] [VCD]

Change the zoom ratio so the picture expands to the optimum size to fill the screen.

During play

Press **[ZOOM]** to select the preset aspect ratio.



The zoom ratio changes each time you press the button.

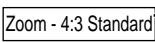

The popup shows the video format suited to the ratio.

4:3 Standard → European Vista → 16:9 Standard

Cinemascope2 ← Cinemascope1 ← American Vista

Refer to the disc's instructions and "Screen size" below for the aspect ratio of the picture.

### ■ Making fine adjustments to the zoom ratio

While the ZOOM icon is displayed:

Press **[▲, ▼]**.

The ratio changes in 0.01 units between 1.00 and 1.60 and in 0.02 units between 1.60 and 2.00.

To restore the original ratio

Press **[ZOOM]** until the ratio returns to 1.00.

The ratio also returns to 1.00 when you change the disc or switch the unit to standby. The ratio may return to 1.00 when a menu is displayed.

### ■ Screen size

Movies are made using a variety of screen sizes.

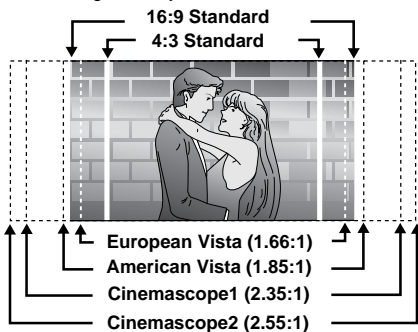

## Double re-master—Enjoying more natural sound

[RAM] [DVD-A] [DVD-V] [CD]

**Discs recorded with 2-channel LPCM at 44.1 kHz or 48 kHz**

This feature gives you a more natural sound by adding the higher frequency signals not recorded on the disc.

[WMA] [MP3]

**Discs recorded at 44.1 kHz or 48 kHz**

This feature reproduces the frequencies lost during recording to give you a sound closer to the original.

During play

Press **[DOUBLE RE-MASTER]**.



Output sampling frequency

Each time you press the button:

Setting	[RAM] [DVD-A] [DVD-V] [CD] Type of music	[WMA] [MP3] Effect level
1	High tempo (e.g., pops and rock)	Light
2	Various tempos (e.g., jazz)	Medium
3	Low tempo (e.g., classical)	Strong
OFF	Off	Off

[Note]

The actual output sampling frequency depends on the PCM Digital Output setting when using a digital connection (→ page 21).

## Setting the unit to turn off—SLEEP timer

Press **[SLEEP]** to select the setting.

Each time you press the button:

- OFF: cancel
- ↓ AUTO: turns the unit off 5 minutes after play finishes
- ↓ 60 min: turns the unit off after 60 minutes
- ↓ 90 min: turns the unit off after 90 minutes
- ↓ 120 min: turns the unit off after 120 minutes



- AUTO also works with DVDs that show a menu after play finishes.
- AUTO does not work if you press **[■]**, **[MENU]** or **[TOP MENU]**. It is activated again when you restart play.
- AUTO does not work correctly with some discs (e.g., if menus appear after playing Video CDs).

To confirm the remaining time

Press **[SLEEP]**.

### ■ Auto standby

The unit switches to standby mode after about 30 minutes in the stop mode, irrespective of the SLEEP setting.

## To enjoy even higher quality sound—AUDIO ONLY

[RAM] [DVD-A] [DVD-V] [VCD] [CD] [WMA] [MP3]

You can enjoy higher quality audio by stopping the video signal.

**Main unit only**

During play

Press **[AUDIO ONLY]**.

- AUDIO ONLY is canceled if you press the button again or turn the unit off.

[Note]

- Video is output when you stop the disc and during operations such as search.
- The television screen can appear unusual while video signals are not being output.

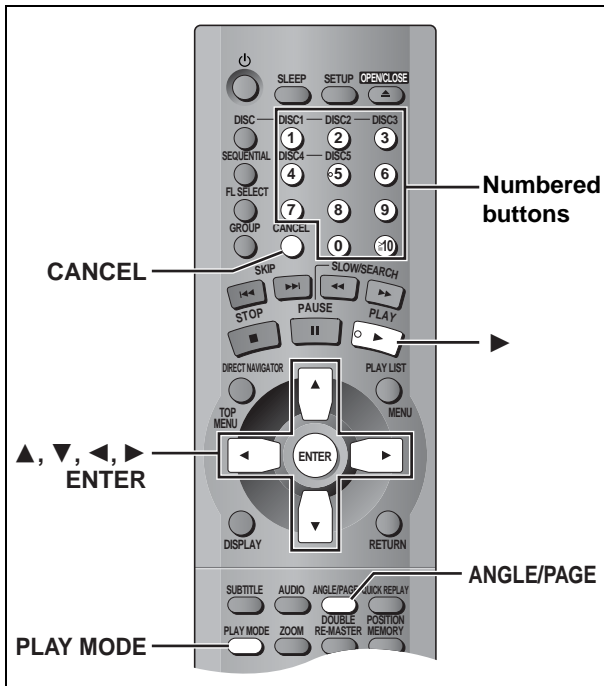

While stopped

Press [PLAY MODE].

The display changes each time you press the button.

Program → Random → Off (normal)

## Random play

**When Sequential Mode is on**

[VCD] [CD] [WMA] [MP3]

You can play all the items on all the discs in random order.

**When Sequential Mode is off**

[RAM] [VCD] [CD] [WMA] [MP3]

You can play all the items on a disc in the play position in random order.

[DVD-A] [DVD-V]

You can play selected item(s) on a disc in the play position in random order.

1 [WhenSequentialModeis\off]

[DVD-A] [DVD-V]

**Press the numbered buttons to select a group or a title.**

[DVD-V]

•Some items cannot be selected.

[DVD-A]

•You can select more than one group.

To enter all groups, select "All" using

[◀, ▶] and press [ENTER].

•To deselect a group, press the numbered buttons corresponding to the group you want to clear.

e.g. [DVD-V]



2 Press [▶] (PLAY).

## Program play

You can select up to 32 items to play in the order you choose.

**When Sequential Mode is on**

[VCD] [CD] [WMA] [MP3]

You can program all the items on discs.

**When Sequential Mode is off**

[RAM] [DVD-A] [DVD-V] [VCD] [CD] [WMA] [MP3]

You can program all the items on a disc in the play position.

1 [WhenSequentialModeis\on]

**Press the numbered buttons to select a disc.**

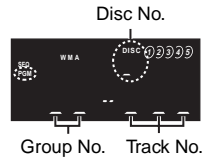
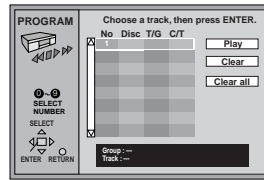

2 [DVD-A] [DVD-V] [WMA] [MP3]

**Press the numbered buttons to select a group or title.**

[DVD-V]

•Some items cannot be selected.

3 **Press the numbered buttons to select a program, track or chapter.**  
(Press [ENTER] if the number continues to flash.)

•Repeat steps 1–3 to program other items.

4 Press [▶] (PLAY).

Some items will not be played, even if you can enter them in the program.

**To select using the cursor buttons**

Press [ENTER] and [▲, ▼] to select an item, then press [ENTER] again to register. Select "ALL" to enter all items (on the disc or in the title or group).

**Changing the program**

Press [▲, ▼] to select an item.

–To change an item, repeat steps 1–3.

–To clear an item, press [CANCEL] (or select "Clear" and press [ENTER]).

•Press [ANGLE/PAGE] to skip items.

**To clear the whole program**

Select "Clear all" with [▲, ▼, ◀, ▶] and press [ENTER]. The whole program is also cleared when the disc is moved out of the play position while the sequential mode is off or the unit is turned off.

**To exit the program/random mode**

Press [PLAY MODE] while stopped.

**If you select a bonus group on a DVD-Audio**

Enter the password with the numbered buttons. Refer also to the disc's jacket.

[Note]

Disable HighMAT disc play to use random and program play.

In the SETUP menu, set "HighMAT" to "Disable" (→ page 20) and perform the necessary operations (→ above).



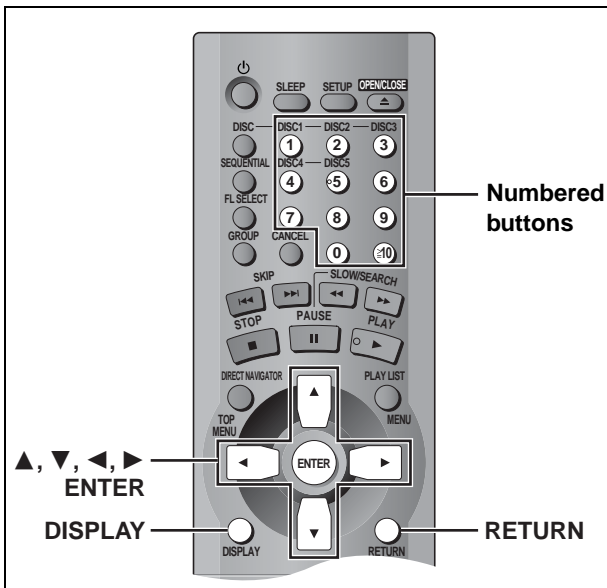

On-Screen Menu Icons are menus that contain information about the disc or unit and allow you to perform operations by changing this information.

## Common procedures

- 1 Press [DISPLAY].**  
Each time you press the button:  
Disc information (→ right) → Progress indicator (→ page 19)  
↑  
Original display ← → Unit information (→ page 18–19)
- 2** [Unit\information\only]  
While the leftmost icon is highlighted  
Press [**▲**, **▼**] to select the menu.  
Each time you press the button:  
Play Menu ↔ Picture Menu ↔ Audio Menu ↔ Display Menu
- 3 Press [◀, ▶] to select the item.**
- 4 Press [**▲**, **▼**] to select the setting.**
  - Change items with “▲” or “▼” above and below with [**▲**, **▼**] (press [ENTER] if the setting doesn't change).
  - Change numbered items with the numbered buttons and press [ENTER].
  - Depending on the condition of the unit (playing, stopped, etc.) and the type of software, there are some items that you cannot select or change.
  - Read the following explanations for other items.

### To clear the menus

Press [RETURN] until the menus disappear.

### To change the position of the icons

1. Press [◀, ▶] to select the Bar Position icon.
2. Press [**▲**, **▼**] to move the icons. (There are 5 positions.)



## Disc information

e.g. [DVD-V]	[RAM] <b>PG:</b> Program number <b>PL:</b> Play list number
	[DVD-V] <b>T:</b> Title number <b>C:</b> Chapter number
	[VCD] [CD] <b>T:</b> Track number [DVD-A] [WMA] [MP3] <b>G:</b> Group number <b>T:</b> Track number in group
	[JPEG] <b>G:</b> Group number <b>P:</b> Picture number in group
	<b>Time</b> [RAM] [DVD-A] [DVD-V] • Press [ <b>▲</b> , <b>▼</b> ] to show the elapsed play time or remaining time for the program, play list, group, track or title (or chapter during program and random play). • Select a position to start play by specifying a time with the numbered buttons and press [ENTER]. <b>Changing the time display</b> [VCD] [CD] Press [ <b>▲</b> , <b>▼</b> ] to show the elapsed play time, remaining time for the track, or remaining time for the disc. <b>Elapsed play time</b> [VCD] (SVCD only) [WMA] [MP3] For display only, cannot be changed.
	<b>Audio mode</b> (→ page 14, Soundtracks) <b>Soundtrack language</b> (See [A] below for language abbreviations.) <b>Audio signal type</b> (See [B] below for details.) <b>Karaoke vocal on/off</b> (Karaoke DVD only) [DVD-V] Solo: OFF or ON Duet: OFF, V1 + V2, V1 or V2 <b>Current bitrate</b> [WMA] [MP3] <b>Current sampling frequency</b> [WMA] [MP3]
	<b>Subtitle language</b> (→ page 14) (See [A] below for language abbreviations.) <b>Subtitles on/off</b> ON ↔ OFF <b>Track information on/off</b> [CD] (CD text only) [WMA] [MP3] ON ↔ OFF <b>Picture information</b> [JPEG] Full: Group title, picture title, picture size, file size, date of shooting, and camera model used*. Date: Date of shooting only. OFF: No display. * Actual displays depend on the camera and data.
	<b>Angle number</b> (→ page 14)
	[WMA] [MP3] <b>Track number in disc/total number of tracks on disc</b> [JPEG] <b>Picture number in disc/total number of pictures on disc</b>
	<b>Menu play</b> [VCD] Indicates whether menu play (playback control) is on or off.
	<b>Still picture number</b> [DVD-A] Selected picture is shown during play. <b>Slideshow setting</b> [JPEG] ON ↔ OFF <b>Slideshow timing</b> [JPEG] 0–30 sec

### [A] Audio/Subtitle language

ENG: English	SVE: Swedish	CHI: Chinese
FRA: French	NOR: Norwegian	KOR: Korean
DEU: German	DAN: Danish	MAL: Malay
ITA: Italian	POR: Portuguese	VIE: Vietnamese
ESP: Spanish	RUS: Russian	THA: Thai
NLD: Dutch	JPN: Japanese	*: Others

### [B] Signal type/data

LPCM/PPCM/□□ Digital/DTS/MPEG: Signal type  
k (kHz): Sampling frequency  
b (bit): Number of bits  
ch (channel): Number of channels  
Example: 3/2\_1ch

- 1: Low frequency effect  
(not displayed if there is no signal)
- 0: No surround
- 1: Mono surround
- 2: Stereo surround (left/right)
- 1: Center
- 2: Front left+ Front right
- 3: Front left+ Front right+ Center

Unit information



Play Menu

	<p><b>A-B repeat</b> [RAM] [DVD-A] [DVD-V] [VCD] [CD] [WMA] [MP3] (When the elapsed play time is displayed) Repeat a section between points A and B within an item.</p> <p>[ENTER] (start point) → [ENTER] (finish point) To cancel: [ENTER]</p> <ul style="list-style-type: none"> <li>• Subtitles recorded around A and B may fail to appear.</li> <li>• The end of an item becomes point B when it is reached.</li> <li>• A-B repeat is canceled when you press [QUICK REPLAY].</li> </ul>
	<p><b>Repeat mode</b> [RAM] [DVD-A] [DVD-V] [VCD] [CD] [WMA] [MP3] (When the elapsed play time is displayed) [JPEG]</p> <p>[RAM] [DVD-A] [DVD-V] PG: Program*1 S: Scene*3 T: Track*1 C: Chapter*1 D: Disc*2 PL: Playlist*3 G: Group*2 T: Title*2 OFF OFF OFF [VCD] [CD] [WMA] [MP3] [JPEG] T: Track*1 G: Group D: Disc*2 *4 OFF S: Sequential*5 OFF</p> <p>*1 "1 (1 Step)" during program play: repeats the current program item. *2 "A (All)" during program and random play. "S (Sequential)" appears instead of "A" if Sequential mode is on to repeat play of all loaded discs (except DVDs). *3 During play list play *4 "G (Group)" when Sequential mode is off [WMA] [MP3] *5 Appears only when Sequential mode is on.</p> <ul style="list-style-type: none"> <li>• You can also repeat play of content ("C") and group ("G") on HighMAT discs.</li> <li>• <b>If the Video CD has playback control</b> <ol style="list-style-type: none"> <li>1. Press [■] to clear "PBC" from the display.</li> <li>2. Press the numbered buttons to select a track to start play.</li> <li>3. Select an item to repeat.</li> </ol> </li> <li>• <b>To repeat only your favorite programs/tracks/chapters</b> Start program play (→ page 16) and display "A".</li> </ul>
	<p><b>Play mode display</b> [RAM] [DVD-A] [DVD-V] [VCD] [CD] [WMA] [MP3] ---: Normal play PGM: Program play RND: Random play</p>
	<p><b>Marker</b> [RAM] : 999 positions [DVD-A] [DVD-V] [VCD] [CD] [WMA] [MP3] [JPEG] : 5 positions [ENTER] (The unit is now ready to accept markers.) To mark a position: [ENTER] (at the desired point) To mark another position: [◀, ▶] → [ENTER] To recall a marker: [◀, ▶] → [ENTER] To erase a marker: [◀, ▶] → [CANCEL] [RAM]</p> <p>To mark the eleventh point and beyond</p> <ol style="list-style-type: none"> <li>1. Press [◀, ▶] to select the marker pin icon </li> <li>2. Press [▲, ▼] to select "11-20" • You can select the next group when the current group is full.</li> <li>3. Press [▶].</li> </ol> <ul style="list-style-type: none"> <li>• The markers are ordered by time. This means that the marker numbers can change when you add and erase markers.</li> <li>• If places have been marked (e.g., with a DVD video recorder), they are displayed.</li> <li>• You can clear existing markers, but they are restored when you change the disc or switch the unit to standby.</li> <li>• This feature doesn't work while using a play list.</li> </ul> <p>[Note] • This feature doesn't work during program and random play. • Markers you add clear when you change the disc or switch the unit to standby.</p>



Picture Menu

	<p><b>Picture mode</b> N: Normal mode S: Soft mode (Soft picture with fewer video artifacts) F: Fine mode (Details are sharper)</p> <p><b>C1 (Cinema1):</b> Mellows images and enhances detail in dark scenes</p> <p><b>C2 (Cinema2):</b> Sharpens images and enhances detail in dark scenes</p> <p><b>U1/U2/U3:</b> User mode (→ below)</p>
	<p><b>Video output mode</b> 480I: Interlace video 480P: Progressive video</p> <ul style="list-style-type: none"> <li>• You can change the video output mode only when "Progressive Out (Component)" in the SETUP menu is set to "Enable" (→ page 20).</li> <li>• When progressive output is on, closed captions will not be displayed.</li> </ul>
	<p><b>Transfer mode</b> Select the method of conversion for progressive output to suit the type of material being played (→ page 23, Glossary—Film and video). <b>Auto1</b> (normal): For viewing film material <b>Auto2:</b> For viewing film material (the same as Auto1, but able to convert 30-frame-per-second progressive video) <b>Video:</b> For video material</p>
<p><b>■ User mode</b> Press [▶] while "U1" is highlighted and then press [▲, ▼] to select "1", "2" or "3".</p>	
<p><b>U1: MPEG D.N.R. (Digital Noise Reduction)</b></p>	
	<p><b>Depth Enhancer</b> (0 to +4) Reduces the rough noise in the background to give a greater feeling of depth.</p>
	<p><b>3D-NR</b> (0 to +4)/<b>Dot NR</b> (On) Reduces overall noise/Reduces the dot noise that occurs at the borders between colors.</p>
	<p><b>Block NR</b> (0 to +3) Smooths block noise.</p>
	<p><b>Mosquito NR</b> (0 to +3) Reduces the smudging that appears around contrasting sections of the picture.</p>
<p><b>U2: Picture Control</b></p>	
	<p><b>Contrast</b> (-7 to +7) Adjusts the contrast between light and dark parts of the picture.</p>
	<p><b>Brightness</b> (0 to +15) Adjusts the picture brightness.</p>
	<p><b>Sharpness</b> (-7 to +7) Adjusts the sharpness of the edges of the horizontal lines.</p>
	<p><b>Color</b> (-7 to +7) Adjusts the shade of the picture's color.</p>
	<p><b>Gamma</b> (0 to +5) Adjusts the brightness of dark parts of the picture.</p>
<p><b>U3 (Video output mode → above)</b></p>	

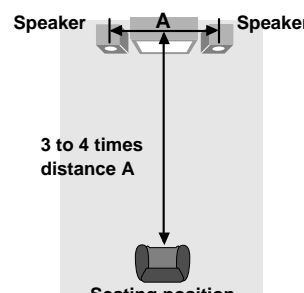

## Audio Menu

	<p><b>Advanced surround (VSS)</b> [RAM] [DVD-V] [VCD] <b>(2-channel or greater)</b> Enjoy a surround-like effect when using 2 front speakers (SP) or headphones (HP) (connect the unit to equipment that has a headphone jack). The effect broadens when playing discs with surround effects and sound seems to come from speakers on either side of you.</p> <ul style="list-style-type: none"> <li>•<b>VSS mode:</b> SP ↔ HP</li> <li>•<b>SP/HP level</b> <ol style="list-style-type: none"> <li>1: Natural effect</li> <li>2: Emphasized effect</li> </ol> </li> <li>•<b>OFF:</b> Cancel (Factory preset)</li> </ul> <p>To change SP/HP level: [▶] → [▲, ▼]</p>
	<p><b>Optimum seating position</b></p>  <p>&lt;When using the television's speakers&gt; Distance A = Television's width</p> <p>3 to 4 times distance A</p> <p>Seating position</p> <ul style="list-style-type: none"> <li>•This does not work or has less effect with some discs.</li> <li>•Turn off if it causes distortion.</li> <li>•Do not use in combination with surround effects on other equipment.</li> </ul>
	<p><b>Double re-master</b> (→ page 15)</p>
	<p><b>Dialogue enhancer</b> [DVD-V] <b>(Dolby Digital, DTS, 3-channel or over, where the dialogue is recorded in the center channel)</b> This makes the dialogue in movies easier to hear. ON ↔ OFF (Factory preset)</p> <ul style="list-style-type: none"> <li>•This does not work or has less effect with some discs.</li> </ul>
	<p><b>Attenuator (For analog connection)</b> Switch on if sound is distorted. ON ↔ OFF (Factory preset)</p>

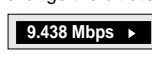
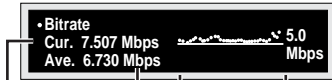

## Display Menu

	<p><b>4:3 Aspect</b> Select how to show images made for 4:3 aspect screens on a 16:9 aspect television.</p> <ul style="list-style-type: none"> <li>•<b>Normal:</b> Laterally stretches images made for a 4:3 screen.</li> <li>•<b>Auto:</b> Expands suitable 4:3 letterbox images to fill more of the screen. Other images appear in full in the center of the screen.</li> <li>•<b>Shrink:</b> Images appear in the center of the screen.</li> <li>•<b>Zoom:</b> Expands all images to fill the screen.</li> </ul> <p>If your television has a similar feature, use it instead for a better effect.</p>
	<p><b>Zoom</b> (→ page 15) <b>To select preset aspect ratio</b> Press [ENTER] and then [◀, ▶] to select. Press [ENTER] to finish.</p>
	<p><b>Subtitle Position/Subtitle Brightness</b> (→ page 14)</p>
	<p><b>Bitrate Display on/off</b> [RAM] [DVD-A] (Moving picture part) [DVD-V] [VCD] When you select "ON": During play: shows the average bitrate of the video being played While paused: shows the data volume of the frame and type of picture (→ page 23, Glossary— I/P/B)</p> <p>To change the bitrate display:</p>   <p>Current bitrate   Average bitrate   A record of bitrates for a sampling period</p>
	<p><b>OSD Brightness</b> (-3 to +3) Adjust the brightness of the on-screen displays.</p>

## Progress indicator

Indicates how far you have played through an item.

e.g. [DVD-V]

Current position



Condition – play, pause, or slow/search

**Changing the time display** [RAM] [DVD-A] [DVD-V] [VCD] [CD]

Press [▲, ▼] to show the elapsed play time or remaining time for the program, play list, track or title (or chapter during program and random play).

**Elapsed play time** [VCD] (SVCD only) [WMA] [MP3]

For display only, cannot be changed.

■ **Changing play speed** [DVD-A] (Moving picture part) [DVD-V] (Dolby Digital only)

Press [◀] (slower) or [▶] (faster).

There are five speeds:

×0.8 ↔ ×0.9 ↔ ×1.0 (normal speed) ↔ ×1.2 ↔ ×1.4

•After you change the speed:

–Output is in stereo,

–Advanced surround does not work,

–Digital output switches to PCM.

•Sound is stereo as long as "×1.0" is orange.





**To return to normal play**

Press [▶] (PLAY).



# Changing settings

This chart shows the settings for this unit. Change the settings to suit your preferences and to suit the unit to the environment in which it is being used. The changes remain intact even if you switch the unit to standby. See page 21 for operation.

Menus	Items	Options (Underlined items are the factory preset.)
	<b>Audio</b> Choose the audio language.	English    French    Spanish Original* <sup>1</sup> Other **:*:* <sup>2</sup>
	<b>Subtitle</b> Choose the subtitle language.	Automatic* <sup>3</sup> English    French Spanish    Other **:*:* <sup>2</sup>
	<b>Menus</b> Choose the language for disc menus.	English    French    Spanish Other **:*:* <sup>2</sup>
	<b>Ratings (→ page 21)</b> ● Set a ratings level to limit DVD-Video play. ● The password screen is shown if you choose levels 0 to 7 or if you choose "Ratings" when levels 0 to 7 have been selected. ● Select "Level 0" to prevent play of discs that do not have ratings levels recorded on them.	<b>Setting ratings (When level 8 is selected)</b> 8 No Limit    1 to 7* <sup>4</sup> 0 Lock All <b>Changing ratings (When level 0-7 is selected)</b> Unlock Player    Change Password Change Level    Temporary Unlock
	<b>TV Aspect (→ page 9)</b> Choose the setting to suit your television and preference.	4:3 Pan&Scan    4:3 Letterbox    16:9
	<b>Progressive Out (Component)</b> Choose "Enable" to enable progressive output.	Disable    Enable
	<b>TV Type</b> Select to suit the type of television.	Standard (Direct View TV)    CRT Projector LCD TV/Projector    Projection TV Plasma TV
	<b>Still Mode</b> Specify the type of picture shown when paused.	Automatic    Field    Frame
	<b>Black Level Control</b> Change the black level of the picture if you connected a television through the COMPONENT VIDEO OUT terminals.	Lighter: When connected through VIDEO OUT or S VIDEO OUT. Darker: When connected through COMPONENT VIDEO OUT (Y/P <sub>B</sub> /P <sub>R</sub> ).
	<b>Speaker Setting (→ page 22, Speaker setting)</b> Choose the settings to suit your audio system and the listening environment.	<b>Multi-channel:</b> when 3 or more speakers are connected. ● Speaker presence and size ● Delay time    ● Channel balance <b>2-channel:</b> when 2 speakers or an amplifier with a Dolby Pro Logic decoder is connected.
	<b>PCM Digital Output (→ page 21)</b>	Off    Up to 48 kHz Up to 96 kHz    Up to 192 kHz
	<b>Dolby Digital (→ page 21)</b>	Bitstream    PCM
	<b>DTS Digital Surround (→ page 21)</b>	PCM    Bitstream
	<b>Dynamic Range Compression (Dolby Digital only)</b> Change the dynamic range for late night viewing.	Off    On
	<b>Audio during Search*<sup>5</sup></b> Choose whether to have sound during search.	On    Off
	<b>Menu Language</b> Choose the language for these menus and the on-screen messages.	English    Français    Español
	<b>On-Screen Messages</b> Choose whether to show on-screen messages or not.	On    Off
	<b>FL Dimmer</b> Changes the brightness of the unit's display.	Bright Dim Auto: The display is dimmed during play, but brightens when you perform operations such as slow-motion, search, and pause.
	<b>Others</b>	<b>HighMAT</b> Play HighMAT discs as HighMAT discs, or as regular WMA/MP3/JPEG discs. Enable: Play HighMAT discs as HighMAT discs. Disable: Play HighMAT discs as regular WMA/MP3/JPEG discs.
	<b>Mixed Disc—Audio &amp; Stills</b> Select which type of file the unit plays when playing a disc containing both JPEG and WMA/MP3.	Audio (MP3/WMA)    Stills (JPEG)
	<b>DVD-Video Mode</b> Select how to play pictures contained on some DVD-Audio. The setting returns to "Off" when you change the disc or turn the unit off.	Off: DVD-Audio are played as DVD-Audio. On: You can play DVD-Video content on DVD-Audio.
	<b>Demo</b>	Off On: A demonstration of the on-screen displays starts. Press any button to stop it.
	<b>QUICK SETUP (→ page 9)</b> Answer questions to make basic settings.	Yes    No

\*<sup>1</sup> The original language of each disc is selected.

\*<sup>2</sup> Input a code number with the numbered buttons (→ page 21).

\*<sup>3</sup> If the language selected for "Audio" is not available, subtitles of that language will automatically appear if available on that disc.

\*<sup>4</sup> Prohibits play of DVD-Video with corresponding ratings recorded on them.

\*<sup>5</sup> Audio will be heard when playing some DVD-Audio despite the settings you make here.

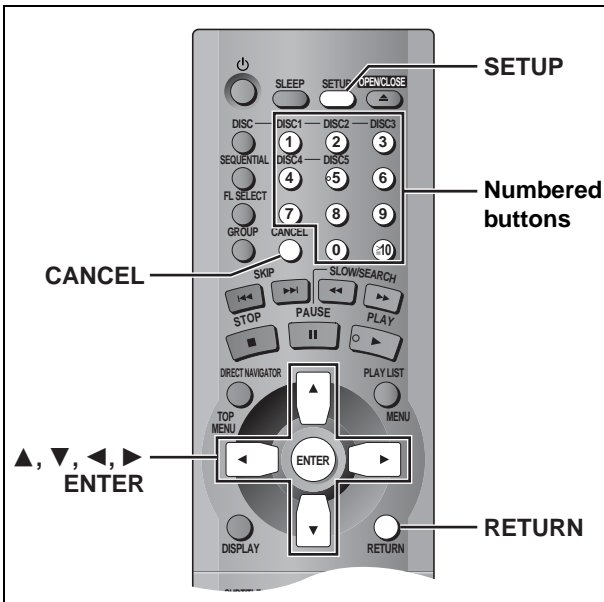

## Common procedures

See page 20 for menu and option details.

### 1 Press [SETUP] to show the menus.

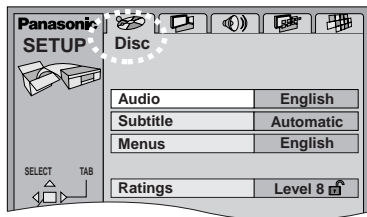

• The QUICK SETUP screen appears when you press [SETUP] the first time after purchase (→ page 9).

### 2 Press [◀, ▶] to select the menu's tab.

The screen changes to display the menu.

Disc ↔ Video ↔ Audio ↔ Display ↔ Others

### 3 Press [▲, ▼] to select the item you want to change and press [ENTER].

### 4 Press [▲, ▼, ▶, ◀] to select the option and press [ENTER].

The screen now shows the menu again.

**To return to the previous screen**

Press [RETURN].

**To exit the SETUP menu**

Press [SETUP].

## Language code list

Abkhazian: 6566	Byelorussian: 6669	Georgian: 7565	Kashmiri: 7583	Mongolian: 7778	Serbo-Croatian: 8372	Tigrinya: 8473
Afar: 6565	Cambodian: 7577	German: 6869	Kazakh: 7575	Nauru: 7865	Shona: 8378	Tonga: 8479
Afrikaans: 6570	Catalan: 6670	Greek: 6976	Kirghiz: 7589	Nepali: 7869	Sindhi: 8368	Turkish: 8482
Albanian: 8381	Chinese: 9072	Greenlandic: 7576	Korean: 7579	Norwegian: 7879	Singhalese: 8373	Turkmen: 8475
Ameharic: 6577	Corsican: 6779	Guarani: 7178	Kurdish: 7585	Oriya: 7982	Slovak: 8375	Twi: 8487
Arabic: 6582	Croatian: 7282	Gujarati: 7185	Laotian: 7679	Pashto, Pushto: 8083	Slovenian: 8376	Ukrainian: 8575
Armenian: 7289	Czech: 6783	Hausa: 7265	Latin: 7665	Polish: 8076	Somali: 8379	Urdu: 8582
Assamese: 6583	Danish: 6865	Hebrew: 7387	Latvian, Lettish: 7686	Portuguese: 8084	Spanish: 6983	Uzbek: 8590
Aymara: 6588	Dutch: 7876	Hindi: 7273	Lingala: 7678	Punjabi: 7684	Sundanese: 8385	Vietnamese: 8673
Azerbaijani: 6590	English: 6978	Hungarian: 7285	Lithuanian: 7684	Quechua: 8185	Swahili: 8387	Volapük: 8679
Bashkir: 6665	Esperanto: 6979	Icelandic: 7383	Macedonian: 7775	Rhaeto-Romance: 8277	Swedish: 8386	Welsh: 6789
Basque: 6985	Estonian: 6984	Indonesian: 7378	Malagasy: 7771	Romanian: 8279	Tagalog: 8476	Wolof: 8779
Bengali; Bangla: 6678	Faroese: 7079	Interlingua: 7365	Malay: 7783	Russian: 8285	Tajik: 8471	Xhosa: 8872
Bhutani: 6890	Fiji: 7074	Irish: 7165	Malayalam: 7776	Samoan: 8285	Tamil: 8465	Yiddish: 7473
Bihari: 6672	Finnish: 7073	Italian: 7384	Maltese: 7784	Sanskrit: 8365	Tatar: 8484	Yoruba: 8979
Breton: 6682	French: 7082	Japanese: 7465	Maori: 7773	Scots Gaelic: 7168	Telugu: 8469	Zulu: 9085
Bulgarian: 6671	Frisian: 7089	Javanese: 7487	Marathi: 7782	Serbian: 8382	Thai: 8472	
Burmese: 7789	Galician: 7176	Kannada: 7578	Moldavian: 7779	Tibetan: 6679		

## Entering a password (Ratings)

[DVD-V]

The password screen is shown when you select levels 0 to 7.

- Input a 4-digit password with the numbered buttons.
  - If you enter a wrong number, press [CANCEL] to erase it.
- Press [ENTER].
  - The lock symbol appears closed to show the rating is locked.
  - Do not forget your password.**
- Press [ENTER] to confirm the 4 digits.

Now, when you insert a DVD-Video that exceeds the ratings limit you set, a message appears on the television. Follow the on-screen instructions.

## Digital output

[RAM] [DVD-A] [DVD-V] [VCD] [CD] [WMA] [MP3]

Change the settings when you have connected equipment through this unit's DIGITAL AUDIO OUT terminal (OPTICAL).

### PCM Digital Output

Select the maximum sampling frequency of PCM digital output. Check the digital input limitations of the equipment you connect.

**Off:** When not connected digitally

**Up to 48 kHz (Factory preset):**

Signals over 48 kHz converted to 48 or 44.1 kHz

**Up to 96 kHz:** Signals over 96 kHz converted to 48 or 44.1 kHz

**Up to 192 kHz:** Signals up to 192 kHz output

[Note]

- Signals from copy-protected discs are converted to 48 or 44.1 kHz irrespective of the setting.
- Some equipment cannot handle sampling frequencies of 88.2 kHz, even if they can handle 96 kHz. Read your equipment's operating instructions for details.

### Dolby Digital and DTS Digital Surround

**Bitstream (Factory preset for Dolby Digital):**

Select if the equipment you connected can decode the signal.

**PCM (Factory preset for DTS Digital Surround):**

Select if the equipment you connected cannot decode the signal.

### IMPORTANT

If the equipment you connected cannot decode the signal, the setting must be changed to PCM. If not, signals the equipment cannot process will be output by this unit, causing high levels of noise which can damage your hearing and the speakers.

## Speaker setting

For analog connection (→ page 7)

Change speaker presence and size (a), delay time (b), and channel balance (c) to suit the speakers you have connected when you select "Multi-channel" (3 or more speakers are connected).

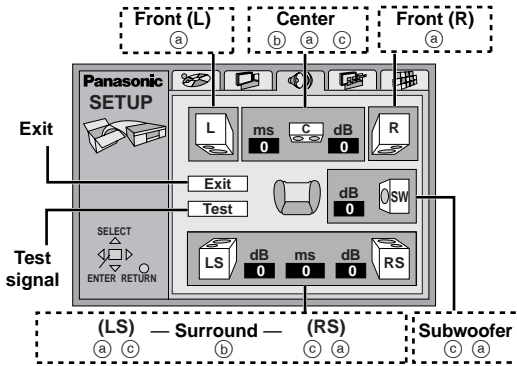

### Speaker presence and size (a)

1. Press [▲, ▼, ◀, ▶] to select the item and press [ENTER].
2. Press [▲, ▼] to select the setting and press [ENTER].

Icon examples:

Surround speaker (LS)

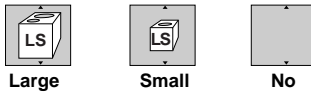

- **Large:** When the speaker supports low-frequency (under 100 Hz) reproduction.
- **Small:** Select when the speaker does not support low-frequency reproduction.

If the subwoofer is set to "No", the front speakers will automatically be set to "Large".

### Delay time (b)

(Effective when playing multi-channel discs)

For optimum listening with 5.1-channel sound, all the speakers, except for the subwoofer, should be the same distance from the seating position. If you have to place the center or surround speakers closer to the seating position, adjust the delay time to make up for the difference.

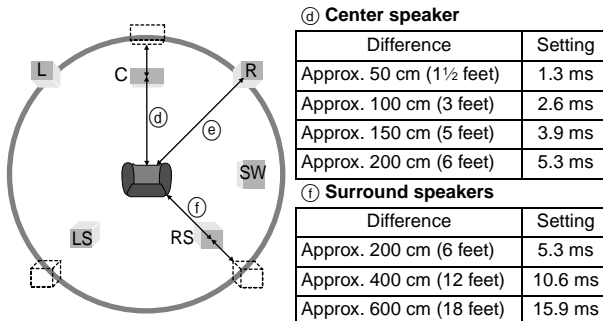

#### ⓐ Center speaker

Difference	Setting
Approx. 50 cm (1½ feet)	1.3 ms
Approx. 100 cm (3 feet)	2.6 ms
Approx. 150 cm (5 feet)	3.9 ms
Approx. 200 cm (6 feet)	5.3 ms

#### ⓑ Surround speakers

Difference	Setting
Approx. 200 cm (6 feet)	5.3 ms
Approx. 400 cm (12 feet)	10.6 ms
Approx. 600 cm (18 feet)	15.9 ms

If distances (d) (from the center speaker) and (f) (from the surround speakers) are the same as or greater than (e) (from the front speakers), leave the delay time as "0", the factory preset.

If either distance (d) or (f) is less than (e), find the difference in the relevant table and change to the recommended setting.

**Changing the delay time**

1. Press [▲, ▼, ◀, ▶] to select the delay time box and press [ENTER].
2. Press [▲, ▼] to adjust the delay time and press [ENTER].

### Channel balance (c)

1. Press [▲, ▼, ◀, ▶] to select "Test" and press [ENTER].  
A test signal is output from one speaker at a time, starting with the front left speaker and proceeding clockwise.

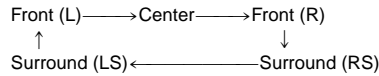

2. While listening to the test signal, press [▲, ▼] to adjust the volume of the center and surround speakers so they are the same apparent volume as the front speakers (-6 to +6).  
(The front speakers cannot be adjusted here.)
3. Press [ENTER].  
The test signal stops.  
• No signal is output for the subwoofer. To adjust its volume, play something, then return to this screen to adjust to suit your taste.

**To finish the speaker setting**

Press [▲, ▼, ◀, ▶] to select "Exit" and press [ENTER].

[Note]

The unit may be unable to output as set here due to limitations imposed by the unit itself or the disc being played. (The display's "D.MIX" indicator goes out in these cases.)

## Bitstream

The digital form of multi-channel data (e.g. 5.1 channel) before decoding.

## Decoder

A decoder restores coded audio signals on DVDs to normal.

## Dolby Digital

This is a method of coding digital signals developed by Dolby Laboratories. Apart from stereo (2-channel) audio, these signals can also be multi-channel audio. A large amount of audio information can be recorded on one disc using this method.

## Dolby Pro Logic

A surround system where a 4-channel audio track is recorded as 2 channels and then is restored to 4 channels for play. The surround channel is monaural and can reproduce up to 7 kHz.

## DTS (Digital Theater Systems)

This surround system is used in many movie theaters around the world. There is good separation between the channels, so realistic sound effects are possible.

## Dynamic range

Dynamic range is the difference between the lowest level of sound that can be heard above the noise of the equipment and the highest level of sound before distortion occurs.

## Film and video

DVD-Videos are recorded using either film or video. Usually, film is recorded at 24 frames per second, the rate movies are filmed at, while video is recorded at 30 frames per second.

## Frame still and field still

Frames are the still pictures that make moving pictures. About thirty are shown each second. A frame still may appear blurred but overall quality is high.

Two fields appear alternately to make up one frame. A field still is not blurred but picture quality is lower.

## Interlace and progressive output

NTSC, the video signal standard, has 480 interlaced (I) scan lines, whereas progressive scanning uses twice the number of scan lines. This is called 480P.

## I/P/B

MPEG 2, the video compression standard adopted for use with DVD-Video, codes frames using these 3 picture types.

**I:** Intra coded picture

This picture has the best quality and is the best to use when adjusting the picture.

**P:** Predictive coded picture

This picture is calculated based on past I or P-pictures.

**B:** Bidirectionally-predictive coded picture

This picture is calculated by comparing past and future I and P-pictures so it has the lowest volume of information.

## Linear PCM (pulse code modulation)

These are uncompressed digital signals, similar to those found on CDs.

# Specifications

## Signal system

NTSC

**Operating temperature range:** +5 to +35 °C (+41 to +95 °F)

**Operating humidity range:** 5 to 90 % RH (no condensation)

## Discs played [8 cm (3") or 12 cm (5")]:

- (1) DVD-RAM (DVD-VR compatible)
- (2) DVD-Audio
- (3) DVD-Video
- (4) DVD-R (DVD-Video compatible)
- (5) CD-Audio (CD-DA)
- (6) Video CD
- (7) SVCD (Conforming to IEC62107)
- (8) CD-R/CD-RW (CD-DA, Video-CD formatted discs)
- (9) MP3/WMA
  - Maximum number of tracks and groups recognizable: 999 tracks and 99 groups
  - Compatible compression rate:
    - MP3: between 32 kbps and 320 kbps
    - WMA: between 48 kbps and 192 kbps
- (10) JPEG
  - Exif Ver 2.1 JPEG Baseline files
  - Maximum number of pictures and groups recognizable: 3000 pictures and 300 groups
  - Picture resolution: between 320×240 and 6144×4096 pixels (Sub sampling is 4:2:2 or 4:2:0)
- (11) HighMAT Level 2 (Audio and Image)

## Video output:

Output level: 1 Vp-p (75 Ω)  
Output terminal: Pin jack (1 system)

## S-video output:

Y output level: 1 Vp-p (75 Ω)  
C output level: 0.286 Vp-p (75 Ω)  
Output terminal: S terminal (1 system)

## Component video output (480P/480I)

Y output level: 1 Vp-p (75 Ω)  
P<sub>B</sub> output level: 0.7 Vp-p (75 Ω)  
P<sub>R</sub> output level: 0.7 Vp-p (75 Ω)  
Output terminal: Pin jack  
(1 system, Y: green, P<sub>B</sub>: blue, P<sub>R</sub>: red)

## Audio output:

Output level: 2 Vrms (1 kHz, 0 dB)  
Output terminal: Pin jack  
Number of terminals: 2 channel:1 system

5.1-channel discrete output (5.1-channel):1 system

## Audio performance:

- (1) Frequency response:
  - DVD (linear audio): 4 Hz–22 kHz (48 kHz sampling)  
4 Hz–44 kHz (96 kHz sampling)
  - DVD-Audio: 4 Hz–88 kHz (192 kHz sampling)
  - CD audio: 4 Hz–20 kHz
- (2) S/N ratio:
  - CD audio: 115 dB
- (3) Dynamic range:
  - DVD (linear audio): 102 dB
  - CD audio: 98 dB
- (4) Total harmonic distortion:
  - CD audio: 0.0025 %

## Digital audio output:

Optical digital output: Optical terminal

## Pickup:

Wave length: 658 nm/790 nm  
Laser power: CLASS IIa/CLASS I

## Power supply:

AC 120 V, 60 Hz

## Power consumption:

15 W

## Dimensions:

430 (W)×405 (D)×59.7 (H) mm  
[16 <sup>15</sup>/<sub>16</sub>" (W)×15 <sup>31</sup>/<sub>32</sub>" (D)×2 <sup>11</sup>/<sub>32</sub>" (H)]

## Mass:

4.1 kg (9.02 lb.)

## Power consumption in standby mode:

approx. 0.6 W

[Note]

Specifications are subject to change without notice. Mass and dimensions are approximate.

# Troubleshooting guide

Before requesting service, make the following checks. If you are in doubt about some of the check points, or if the remedies indicated in the chart do not solve the problem:

**In the U.S.A., contact the Panasonic Customer Call Center at 1-800-211-7262, or e-mail [consumerproducts@panasonic.com](mailto:consumerproducts@panasonic.com), or web site (<http://www.panasonic.com>).**

**In Canada, contact Panasonic Canada Inc. Customer Care Centre at 1-800-561-5505, web site ([www.panasonic.ca](http://www.panasonic.ca)), or an authorized Servicentre closest to you.**

## Power

		Page
No power.	●Insert the AC power supply cord securely into the household AC outlet.	6
The unit is automatically switched to the standby mode.	●The unit automatically switches to standby after approximately 30 minutes in the stop mode. Turn the power back to ON. ●The SLEEP timer functioned.	– 15

## Operation

No response when buttons pressed.	●Some operations may be prohibited by the disc. ●The unit may not be operating properly due to lightning, static electricity or some other external factor. <b>Reset procedure:</b> Press [POWER ⏻/I] to switch the unit to the standby mode and then back to ON. Alternatively, press [POWER ⏻/I] to switch the unit to the standby mode, disconnect the AC power supply cord, and then reconnect it.	– –
No operations can be performed with the remote control.	●Check that the batteries are installed correctly. ●The batteries are depleted: Replace them with new ones. ●Point the remote control at the remote control sensor and operate.	9 9 5
Play doesn't start (or stops immediately) when you press [▶] (PLAY).	●Condensation has formed: Wait 1 to 2 hours for it to evaporate. ●This unit cannot play discs other than the ones listed in these operating instructions. ●You can only play DVD-Video if their region number is "1", "ALL" or multiple region number including "1". ●The disc may be dirty and may require cleaning. ●Ensure that the disc is loaded with the label of the side to be played facing upwards. ●Check that the DVD-RAM has something recorded on it.	– 8 Cover 8 10 –
Cannot play DVDs.	●Sequential Mode is on. Press [SEQUENTIAL] to turn Sequential Mode off.	11
Cannot select alternative languages.	●This function depends on software availability. ●Try selecting from the disc's menu if one is available.	– 10
No menu play.	●This function depends on software availability.	–
No subtitles.	●This function depends on software availability. ●Subtitles are cleared from the television. Turn on the subtitles. ●Subtitle position is wrong. Adjust the position.	– 14 14
Soundtrack and/or subtitle language is not the one selected with the SETUP menus.	●This function depends on software availability.	–
Cannot change angle.	●This function depends on software availability. Even if a disc has a number of angles recorded, these angles may be recorded for specific scenes only.	–
You have forgotten your ratings password. Reset all the settings to Factory Preset.	●While stopped, press and hold [◀◀/▶▶] and [II] on the unit and then also press and hold [▲] on the unit until "Initialized" disappears from the television. Turn the unit off and on again. All settings will return to the default values.	–
The drawer stops while opening.	●There are more than 5 discs in the unit. Remove one or more discs and turn the unit off and on again.	–

## Picture

Picture distorted.	●Some distortion is normal during SEARCH.	–
Menu not displayed correctly.	●Restore the zoom ratio to ×1.00. ●Set the subtitle position to 0. ●Set 4:3 Aspect to "Normal".	15 14 19
No picture.	●Check the connection. ●Make sure the television is on. ●Ensure the television's video input setting (e.g., VIDEO 1) is correct.	6 – –
The picture shown on the television is not normal. (The sides of the picture are cut off, the picture is stretched horizontally, or black bands appear at the top and bottom of the screen.)	●Go to Video in the SETUP menus, and change "TV Aspect" to suit your television. ●Use the television to change the aspect to the correct one. <b>If your television cannot change the aspect when input is progressive, try changing 4:3 Aspect with the On-Screen Menu Icons.</b> ●Turn off the zooming feature of your television if you are using Variable Zoom. ●Ensure that the unit is connected directly to the television, and is not connected through a video cassette recorder.	9, 20 – 19 15 6
There is ghosting when progressive output is on.	●Change Video output mode to "480i". This problem is caused by the editing method or material used on DVD-Video, but should be corrected if you use interlace output.	18
Picture quality is poor.	●Check the settings in the On-Screen Menu Icons' Picture Menu.	18



Sound		Page
<b>No sound.</b> <b>Distorted sound.</b>	•Check the connections.	6, 7
	•Check the volume on the equipment you have connected.	–
	•Ensure that the input settings on the other equipment are correct.	–
	•Turn Advanced surround off if it causes distortion.	19
	•Turn Attenuator on if it causes distortion with analog connection.	19
	•Output from this unit will be in stereo (two channels) when Advanced surround is on. Turn Advanced surround off if you are using three or more speakers.	19
	•If you have connected this unit to an amplifier through the AUDIO OUT terminals, go to the Audio menu in the SETUP menu, and change "Speaker Setting" to suit to your speakers. Select the large or small icon for all the speakers you have connected.	22
	•Due to the specifications on some types of televisions, both video and audio may be cut off when you turn the AUDIO ONLY feature on.	–
	•If the "D.MIX" indicator on the display goes out while playing a multi-channel DVD-Audio disc, sound will only be output from speakers specified by the disc. Read the disc's instructions for details.	–
	•Press [▶] (PLAY) to restore normal play after changing the speed.	19
<b>Piercing noise comes from the speakers.</b>	•Noise may occur when playing WMA files.	–
	•If you have connected this unit to other equipment through the DIGITAL AUDIO OUT terminal, ensure you have selected the correct settings for "Dolby Digital" and "DTS Digital Surround" in the SETUP menus' Audio menu.	21
<b>Effects do not work.</b>	•Dialogue enhancer and Advanced surround do not work when the unit is outputting bitstream signals.	–
	•Advanced surround does not work if you have changed the play speed.	19

### Unit displays

<b>"NOPLAY"</b>	•You inserted a disc the unit cannot play; insert one it can.	8
	•You inserted a blank DVD-RAM.	–
<b>"CHECK"</b>	•Disc is dirty: Wipe it clean.	8
<b>"H□□"</b> □□ stands for a number.	•Trouble may have occurred. The number following "H" depends on the status of the unit.	–
	<b>Reset procedure:</b> Press [POWER ⏻/⏻] to switch the unit to the standby mode and then back to ON. Alternatively, press [POWER ⏻/⏻] to switch the unit to the standby mode, disconnect the AC power supply cord, and then reconnect it.	–
	•If the service numbers fail to clear, note the service number and contact a qualified service person.	–

### Television displays

<b>"Cannot display group xx, picture xx."</b>	•You are trying to display incompatible pictures.	–
<b>"The progressive out is set to "Disable""</b>	•Go to Video in the SETUP menus, and select "Enable" in "Progressive Out (Component)".	20
<b>No on-screen display or only partially displayed.</b>	•Go to Display in the SETUP menus, and select "On" for "On-Screen Messages".	20
	•Press [DISPLAY], and press [◀, ▶] to highlight the Bar Position icon, then press [▲, ▼] to adjust the position.	17
<b>The disc's menu is displayed in a different language.</b>	•Go to Disc in the SETUP menus, and select the preferred language for "Menus".	20

Manufactured under license from Dolby Laboratories. "Dolby", "Pro Logic" and the double-D symbol are trademarks of Dolby Laboratories.

Manufactured under license from Digital Theater Systems, Inc. US Pat. No. 5,451,942, 5,956,674, 5,974,380, 5,978,762 and other world-wide patents issued and pending. "DTS" and "DTS Digital Surround" are registered trademarks of Digital Theater Systems, Inc. © 1996, 2000 Digital Theater Systems, Inc. All rights reserved.

Apparatus Claims of U.S. Patent Nos. 4,631,603, 4,577,216, and 4,819,098, licensed for limited viewing uses only.

This product incorporates copyright protection technology that is protected by method claims of certain U.S. patents and other intellectual property rights owned by Macrovision Corporation and other rights owners. Use of this copyright protection technology must be authorized by Macrovision Corporation, and is intended for home and other limited viewing uses only unless otherwise authorized by Macrovision Corporation. Reverse engineering or disassembly is prohibited.

# Limited Warranty (ONLY FOR U.S.A.)

Panasonic Consumer Electronics Company,  
Division of Matsushita Electric Corporation of America  
One Panasonic Way Secaucus, New Jersey 07094

Panasonic Sales Company, Division of Matsushita Electric  
of Puerto Rico, Inc.

Ave. 65 de Infantería, Km. 9.5  
San Gabriel Industrial Park, Carolina, Puerto Rico 00985

## Panasonic DVD Player/Recorder Limited Warranty

### Limited Warranty Coverage

If your product does not work properly because of a defect in materials or workmanship, Panasonic Consumer Electronics Company or Panasonic Sales Company (collectively referred to as "the warrantor") will, for the length of the period indicated on the chart below, which starts with the date of original purchase ("warranty period"), at its option either (a) repair your product with new or refurbished parts, or (b) replace it with a new or a refurbished product. The decision to repair or replace will be made by the warrantor.

Product or Part Name	Parts	Labor
DVD Player	One (1) Year	Ninety (90) Days
DVD Recorder	One (1) Year	One (1) Year
Rechargeable Batteries, DVD-RAM Disc (in exchange for defective item)	Ten (10) Days	Not Applicable

During the "Labor" warranty period there will be no charge for labor. During the "Parts" warranty period, there will be no charge for parts. You must carry-in or mail-in your product during the warranty period. If non-rechargeable batteries are included, they are not warranted. This warranty only applies to products purchased and serviced in the United States or Puerto Rico. This warranty is extended only to the original purchaser of a new product which was not sold "as is". A purchase receipt or other proof of the original purchase date is required for warranty service.

### Carry-In or Mail-In Service

For Carry-In or Mail-In Service in the United States call 1-800-211-PANA(7262) or visit Panasonic Web Site: <http://www.panasonic.com>  
For assistance in Puerto Rico call Panasonic Sales Company (787)-750-4300 or fax (787)-768-2910.

### Limited Warranty Limits And Exclusions

This warranty ONLY COVERS failures due to defects in materials or workmanship, and DOES NOT COVER normal wear and tear or cosmetic damage. The warranty ALSO DOES NOT COVER damages which occurred in shipment, or failures which are caused by products not supplied by the warrantor, or failures which result from accidents, misuse, abuse, neglect, mishandling, misapplication, alteration, faulty installation, set-up adjustments, misadjustment of consumer controls, improper maintenance, power line surge, lightning damage, modification, or commercial use (such as in a hotel, office, restaurant, or other business), rental use of the product, service by anyone other than a Factory Servicenter or other Authorized Servicer, or damage that is attributable to acts of God.

**THERE ARE NO EXPRESS WARRANTIES EXCEPT AS LISTED UNDER "LIMITED WARRANTY COVERAGE". THE WARRANTOR IS NOT LIABLE FOR INCIDENTAL OR CONSEQUENTIAL DAMAGES RESULTING FROM THE USE OF THIS PRODUCT, OR ARISING OUT OF ANY BREACH OF THIS WARRANTY.** (As examples, this excludes damages for lost time, travel to and from the servicer, loss of media or images, data or other recorded content. The items listed are not exclusive, but are for illustration only.) **ALL EXPRESS AND IMPLIED WARRANTIES, INCLUDING THE WARRANTY OF MERCHANTABILITY, ARE LIMITED TO THE PERIOD OF THE LIMITED WARRANTY.**

Some states do not allow the exclusion or limitation of incidental or consequential damages, or limitations on how long an implied warranty lasts, so the exclusions may not apply to you.

This warranty gives you specific legal rights and you may also have other rights which vary from state to state. If a problem with this product develops during or after the warranty period, you may contact your dealer or Servicenter. If the problem is not handled to your satisfaction, then write to the warrantor's Consumer Affairs Department at the addresses listed for the warrantor.

**PARTS AND SERVICE WHICH ARE NOT COVERED BY THIS LIMITED WARRANTY ARE YOUR RESPONSIBILITY.**

### Customer Services Directory

*For Product Information, Operating Assistance, Literature Request, Dealer Locations, and all Customer Service inquiries please contact:*

*1-800-211-PANA (7262), Monday-Friday 9 am-9 pm; Saturday-Sunday 9 am-7 pm, EST.*

*or send e-mail:*

*[consumerproducts@panasonic.com](mailto:consumerproducts@panasonic.com)*

*For hearing or speech impaired TTY users, TTY: 1-877-833-8855*

*Web Site: <http://www.panasonic.com>*

*You can purchase parts, accessories or locate your nearest servicenter by visiting our Web Site.*

### Accessory Purchases:

1-800-332-5368 (Customer Orders Only)

For hearing or speech impaired TTY users, TTY: 1-866-605-1277  
Panasonic Services Company 20421 84th Avenue South, Kent, WA 98032

(6 am to 5 pm Monday-Friday; 6 am to 10:30 am Saturday; PST)  
(Visa, MasterCard, Discover Card, American Express, Check)

### Service in Puerto Rico

*Matsushita Electric of Puerto Rico, Inc. Panasonic Sales Company/Factory Servicenter:  
Ave. 65 de Infantería, Km. 9.5, San Gabriel Industrial Park, Carolina, Puerto Rico 00985  
Phone (787) 750-4300 Fax (787) 768-2910*

F0102NY1082

## Product Service

- Damage requiring service**—The unit should be serviced by qualified service personnel if:
  - The AC power supply cord or AC adaptor has been damaged; or
  - Objects or liquids have gotten into the unit; or
  - The unit has been exposed to rain; or
  - The unit does not operate normally or exhibits a marked change in performance; or
  - The unit has been dropped or the cabinet damaged.
- Servicing**—Do not attempt to service the unit beyond that described in these operating instructions. Refer all other servicing to authorized servicing personnel.
- Replacement parts**—When parts need replacing ensure the servicer uses parts specified by the manufacturer or parts that have the same characteristics as the original parts. Unauthorized substitutes may result in fire, electric shock, or other hazards.
- Safety check**—After repairs or service, ask the servicer to perform safety checks to confirm that the unit is in proper working condition.

### Product information

For product information or assistance with product operation:

In the U.S.A., contact the Panasonic Customer Call Center at 1-800-211-7262, or e-mail [consumerproducts@panasonic.com](mailto:consumerproducts@panasonic.com), or web site (<http://www.panasonic.com>).

In Canada, contact Panasonic Canada Inc. Customer Care Centre at 1-800-561-5505, web site ([www.panasonic.ca](http://www.panasonic.ca)), or an authorized Servicentre closest to you.

## Conexión a un televisor

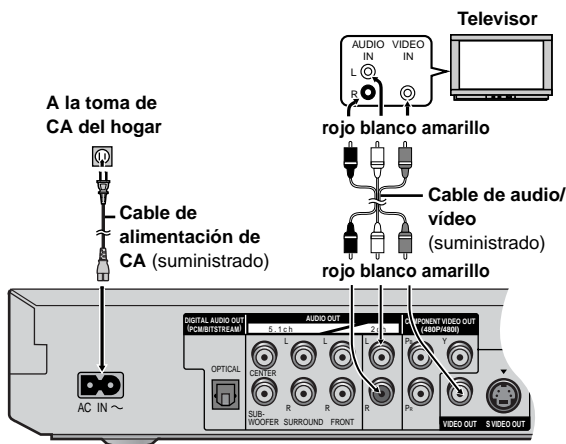

## Preparación rápida

La **pantalla Preparación rápida** aparece cuando usted pulsa [SETUP] por primera vez después de adquirir el aparato y le ayuda a efectuar los ajustes necesarios.

### Preparación

Encienda el televisor y seleccione en él la entrada de vídeo apropiada según las conexiones del reproductor.

1. Pulse [⏻] para encender el aparato.
2. Pulse [SETUP] para visualizar la pantalla QUICK SETUP.
3. Pulse [▲, ▼] para seleccionar "Español" y pulse [ENTER].
4. Pulse [▲, ▼] para seleccionar "Sí" y pulse [ENTER].
5. Pulse [▲, ▼] para seleccionar el elemento y pulse [ENTER].
  - Idioma de audio
  - Idioma de los subtítulos
  - Aspecto de su televisor
  - Televisor
  - Salida progresiva
  - Altoparlantes
  - Salida digital PCM
6. Pulse [ENTER] y después [SETUP] para finalizar los ajustes.

### Para volver a la pantalla anterior

Pulse [RETURN].

## Para disfrutar del vídeo progresivo

### Preparación

- Conecte los terminales de entrada de vídeo componente a un televisor compatible de 480P.
- En Preparación rápida, ponga "Salida progresiva" en "Activar" (→ anterior).

1. Pulse [DISPLAY] para visualizar los menús de iconos.



2. Mientras se resalta el icono del extremo izquierdo, pulse [▲, ▼] para seleccionar "Picture Menu".
3. Pulse [◀, ▶] para seleccionar "Video Output Mode".



4. Pulse [▲, ▼] para seleccionar "480P".
5. Pulse [RETURN] hasta que desaparezcan los menús.

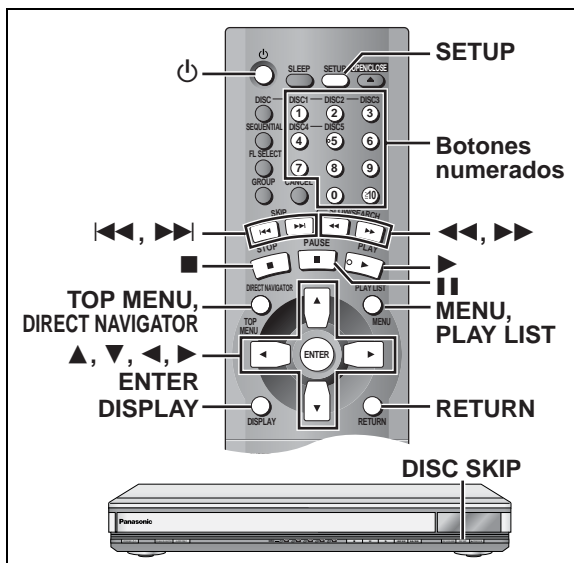

## Reproducción básica

1. Pulse [⏻] para encender el aparato.
2. Pulse [▲] para abrir el mecanismo de carga y coloque el(los) disco(s) en la(s) bandeja(s) con la etiqueta mirando hacia arriba. **Si el disco contiene ambos datos de audio (WMA y MP3) y JPEG**, compruebe el ajuste "Disco mixto Audio/Imág. fija" en el menú de INSTALACIÓN. Seleccione "Imá. fija (JPEG)" o "Audio (MP3/WMA)".
  - Para cargar discos en las otras bandejas, pulse [DISC SKIP] en el aparato principal.
  - La reproducción empieza por el disco delantero izquierdo.
3. Para cargar discos en las otras bandejas, pulse [DISC SKIP] en el aparato principal.
4. Pulse [▶] (PLAY).

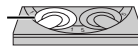

<b>Parada</b>	Pulse [■]. "▷" parpadea en el visualizador. Pulse [▶] (PLAY) para reanudar desde esta posición. Vuelva a pulsar [■] para cancelar la posición.
<b>Pausa</b>	Pulse [⏸]. Pulse [▶] (PLAY) para reanudar la reproducción.
<b>Salto de elementos</b>	Pulse [◀◀] (hacia atrás) o [▶▶] (hacia adelante). <b>Salto de grupo [JPEG]</b> Pulse [▼] (hacia atrás) o [▲] (hacia adelante). <b>Salto de disco</b> Pulse [DISC SKIP] en el aparato principal.
<b>Búsqueda</b>	Pulse [◀◀] (hacia atrás) o [▶▶] (hacia adelante). Pulse [▶] (PLAY) para reanudar la reproducción.
<b>A cámara lenta</b>	Durante la pausa, pulse [◀◀] (hacia atrás) o [▶▶] (hacia adelante). Pulse [▶] (PLAY) para reanudar la reproducción.
<b>Cuadro a cuadro</b>	Durante la pausa, pulse [◀] (hacia atrás) o [▶] (hacia adelante). Pulse y mantenga pulsado para cambiar en sucesión. O bien, pulse [⏸] varias veces para avanzar cuadro a cuadro.
<b>Menús</b>	Pulse [▲, ▼, ◀, ▶] para seleccionar un elemento y [ENTER] para confirmar. O bien, pulse los botones numerados. Pulse [TOP MENU] para visualizar el menú superior. Pulse [MENU] para visualizar un menú. Pulse [RETURN] para visualizar un menú. [VCD] <b>Para visualizar Navegador Directo [RAM]</b> Pulse [DIRECT NAVIGATOR]. <b>Para visualizar el Menú de listas de reproducción [RAM]</b> Pulse [PLAY LIST].

---

**Panasonic Consumer Electronics  
Company, Division of Matsushita  
Electric Corporation of America**  
One Panasonic Way Secaucus,  
New Jersey 07094  
<http://www.panasonic.com>

**Panasonic Sales Company,  
Division of Matsushita Electric of  
Puerto Rico, Inc. ("PSC")**  
Ave. 65 de Infantería, Km. 9.5  
San Gabriel Industrial Park, Carolina,  
Puerto Rico 00985

**Panasonic Canada Inc.**  
5770 Ambler Drive  
Mississauga, Ontario  
L4W 2T3  
[www.panasonic.ca](http://www.panasonic.ca)

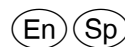

**RQT6977-P**  
F1202FM0